



INSTRUCTION MANUAL

A5 Series Bed

7C00023700A1

Note: In the illustration, an optional mattress is attached.



Preface

Thank you for purchasing **A5 Series Bed**.

This instruction manual describes precautions and how to safely use and operate the bed.

- Before using this bed, please read this instruction manual to fully understand the safe and proper operating procedures.
- The correct operating procedures should be explained not only to the persons using the bed but also to caregivers.
- After reading this instruction manual, store it where it can be easily accessed for later reference.
- The actual product purchased may differ from detailed descriptions given in this instruction manual due to product improvements.
- Values in the specification such as working range, dimensions, angles and mass are subject to normal manufacturing tolerances. Besides some exemptions, display purpose words such as “approximately”, “about” etc. are omitted.
- For any queries, please feel free to directly contact Paramount Bed or your distributor.
- Users and/or patients are requested to report information about any serious incident related to this equipment that occurs within the EU to the manufacturer and the regulating authority of the member country of residence. 'Serious incident' means any incident that directly or indirectly led, might have led or might lead to any of the following:
 - the death of a patient, user or other person.
 - the temporary or permanent serious deterioration of a patient's, user's or other person's state of health.
 - a serious public health threat.

CONTENTS

	Page
1 INTENDED USE / PART NAMES	3
2 SAFETY PRECAUTIONS	4-12
3 INSTALLATION	13
4 ASSEMBLING THE BED	
1. Board	14
2. Mattress stopper	15
5 CONNECTING TO THE POWER SUPPLY	
1. Power outlets	16
2. Cable storage	16
6 OPERATION PROCEDURES	
1. Operation overview	17-18
2. Handheld controller	19-20
3. Side-rail integrated panel	21-22
4. Patient control panel	23
5. Emergency CPR (back-lowering) function	24
6. Adjusting the angle of the leg section base	25
7. Casters	26-27
8. Bed side-rails	28-29
9. Accessory holders	30
10. Detaching the hip section base	30
11. Restraint belt mounting holes	31
12. Angle indicators	31
13. Option attachment holes	32
14. Corner bumpers	32
15. Extension frame function	33
16. Battery unit	34
17. X-ray cassette tray	35-36
7 MATTRESS (OPTIONAL)	37

8 ACCESSORIES

1. Recommended accessories table	38
2. IV pole	39
3. Oxygen cylinder holder (ϕ 155mm)	40
4. Oxygen cylinder holder (ϕ 115mm)	41
5. Lifting pole	42
6. Foot spacer	43
7. Foot spacer storage	43
8. Orthopedic frame attachment	44
9. Foot light	44
10. Monitor table	45
11. Assist bar	46

9 PERIPHERAL EQUIPMENT 47

Overbed table	47
---------------	----

10 PRODUCT SYMBOL DEFINITIONS 48**11 REGULAR INSPECTION AND DAILY MAINTENANCE** 49-50**12 TROUBLESHOOTING** 51-52**13 LONG-TERM STORAGE** 53**14 SPECIFICATIONS** 54-59**15 AFTER-SALES SERVICE** 60**NOTE**

- After pages 4, some part names described in the text are abbreviated as follow:
 - Bed side-rail → Side-rail

1 INTENDED USE / PART NAMES

1. Intended Use

■ This bed is designed to be used for patient care in medical institutions and elderly care facilities.

※ For details of the patient target groups and contra-indications, the intended users and clinical benefits, see "Specifications".

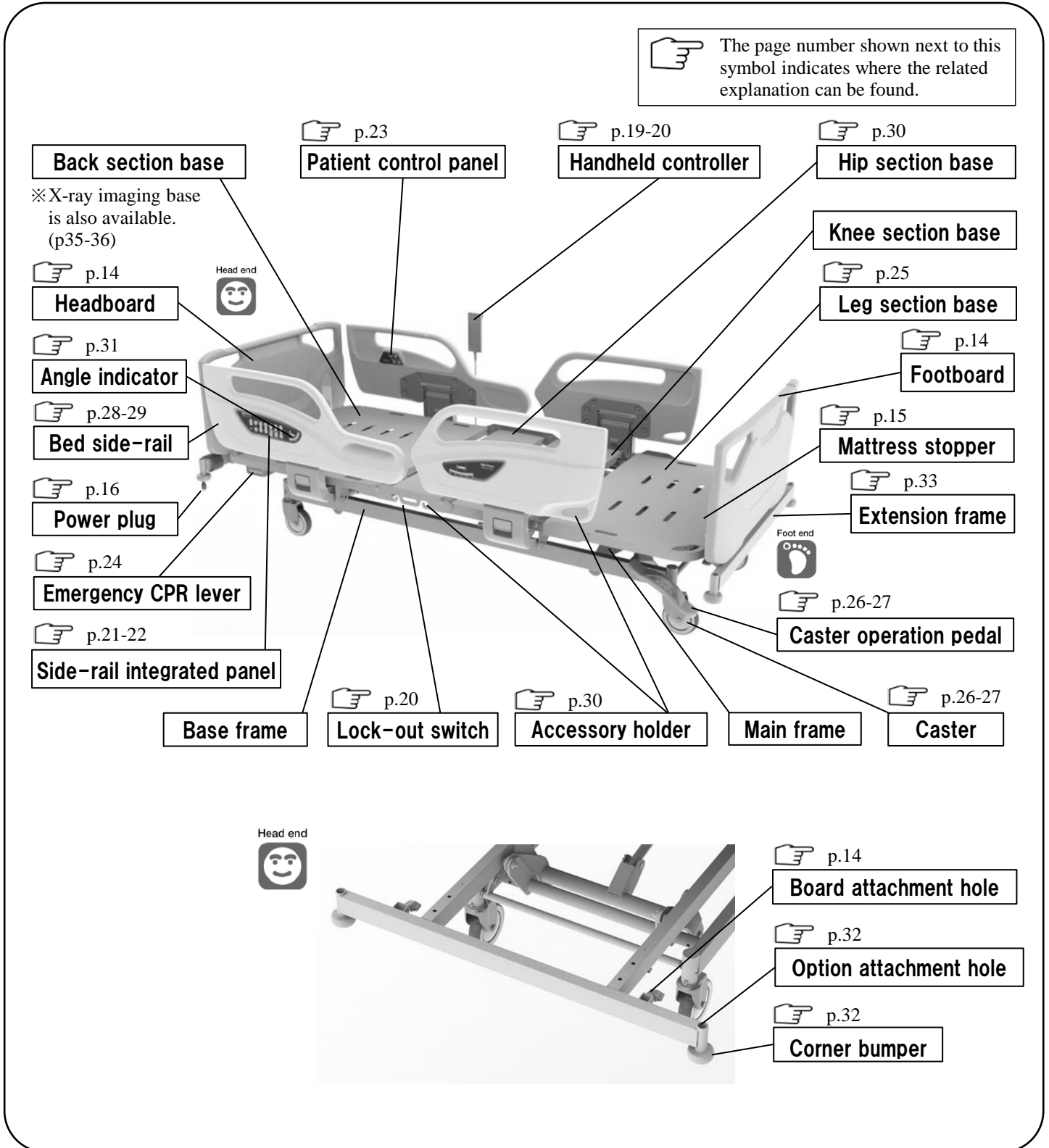

2. Part Names



2 SAFETY PRECAUTIONS

■ Be sure to read these safety precautions beforehand to ensure proper usage.

- The safety precautions described here are intended to ensure safe use of the product and prevent personal injury and property damage. Precautions are classified as "WARNING" and "CAUTION" to indicate the degree of hazard or injury that may result from improper use. **These are important safety precautions that must be strictly observed.**

 WARNING	Indicates actions that may result in death or serious injury (broken bones, pressure or paralysis) if the indication is ignored.
 CAUTION	Indicates actions that may result in light personal injury (bruises, wounds, or cuts) or property damage if the indication is ignored.
Among items described in SAFETY PRECAUTIONS, are especially important because ignoring them could result in serious life-threatening accidents. Be sure to read these notes and use the product safely and properly. Be especially careful to check patients who might act in unexpected ways or cannot maintain their posture independently.	

※ After reading this instruction manual, store it in a place that can be easily accessed for later reference.

[Safety label]

- Precautions requiring special attention by persons using the bed are affixed as pictured in the figure.
- If the safety label is removed or defaced, replace it with a new one obtained from Paramount Bed or your distributor.

On the leg section base



Head end



Foot end



2 SAFETY PRECAUTIONS

WARNING

- Be careful not to allow any part of the body (especially the head or neck) to enter the gap between the side-rail, or the side-rail and the board or the mattress base (especially when raised).



- When the head or neck enters the gap, the patient and/or user might not be able to withdraw, and there is a risk of injury.
- Be especially careful to check patients who might act in unexpected ways or cannot maintain their posture independently.

- Be careful not to allow any part of the body to enter the gap in the side-rail and the board.

- If the bed is operated with a body part placed in the gap, the part may get caught, resulting in injury.
- When the head or neck enters the gap, the patient and/or user might not be able to withdraw, and there is a risk of injury.
- Be especially careful to check patients who might act in unexpected ways or cannot maintain their posture independently.

- Be careful not to allow any part of the body (especially the head or neck) to enter the gap between the side-rail and the mattress base or the mattress.

- If the bed is operated with a body part placed in the gap, the part may get caught, resulting in injury.
- When the head or neck enters the gap, the patient and/or user might not be able to withdraw, and there is a risk of injury.
- Be especially careful to check patients who might act in unexpected ways or cannot maintain their posture independently.

- When performing the height adjustment or inclination angle adjustment with the side-rail lowered, do not place legs under the side-rail.

- There is the risk that the legs may get caught, resulting in injury.

- Do not insert a hand (fingers) or legs between the bed frame and the mattress base during electrical operation.

- The body part may get caught in the gap between the lowered mattress base and the bed frame or the board, resulting in injury.

- Check the patient's condition when adjusting the base angle or bed height.

- If the patient on the bed moves when the base angle or bed height is adjusted, the patient may fall off the bed or get caught in the gap between the bed and the side-rail or the board, resulting in injury. Perform the adjustment while supporting patients who cannot maintain their posture independently.

- Do not crawl or place your head or hands/legs under the bed.



- There is a risk of getting caught between the moving part on the bed and the frame or the side-rail, resulting in injury. Check to make sure there are no people or objects around the bed before operating the bed.

2 SAFETY PRECAUTIONS

WARNING

- Be careful not to allow any part of the body to enter the gap between the bed and wall or surrounding obstacles.
 - There is a risk that a part of the body may get caught, resulting in injury.
- Take care to prevent a patient from falling off the bed even when side-rails are raised.
 - A patient may fall off the bed through the gap between the side-rails, or a board and side-rail, resulting in injury.
 - If a patient bends forward over a side-rail, they may fall off the bed, resulting in injury.
 - Be especially careful to check patients who might act in unexpected ways or cannot maintain their posture independently.
- Do not adjust the side-rails from inside the bed.
 - The side-rails may drop suddenly and there is a risk of injury caused by a patient falling off the bed.
- When transporting a patient, raise the side-rails.
 - There is a risk of the patient falling off the bed, resulting in injury.
- Do not sit on the side-rails, the headboard, or the footboard.



- A patient could fall off the bed, or the bed or side-rails could be damaged or deformed, resulting in injury.

- When leaving the bed area or temporarily taking your eyes off the patient, check the mattress base angle, bed height, and the side-rail status.
 - If a physician, nurse, or caregiver leaves the bed area or temporarily takes their eyes off the patient, flatten the mattress base angle and set the bed height at the lowest position according to the patient's condition because there is a slight chance that the patient could fall off the bed.
 - For patient who cannot maintain their posture independently or have trouble walking, raise all bed side rails.
- Do not allow the bed to be operated by a child aged 12 or under, or someone deemed incapable of comprehending the operation of the bed.
 - If a child aged 12 or under, or someone deemed incapable of comprehending the operation (such as persons with dementia) operates the handheld controller, the side-rail integrated panel or the patient control panel by themselves, there is a risk of unexpected injury such as the body getting caught in the bed by accident. If such person can come into contact with the handheld controller, the side-rail integrated panel or the patient control panel, limit the operation by either of the following methods in order to prevent accidents caused by incorrect operation.
 - Rotate the switch on the Lock-out switch to the lock position to disable the handheld controller operation.
 - Press the Lock button on the side-rail integrated panel to disable the side-rail integrated panel and the patient control panel operation.
 - Unplug the power plug.

2 SAFETY PRECAUTIONS

WARNING

■ Pay attention to prevent the patient from being compressed by back raising.

- Especially before birthing, if the back section base is raised excessively, the patient might be compressed, resulting in injury.

■ Use the bed in the correct orientation.



- Lying down on the bed with the feet at the head end and the head at the feet end induces an unnatural posture during bed operation (base angle) which may result in injury.

■ Do not perform any angle adjustment when the patient is lying face down or on their side (in any posture other than lying face up).

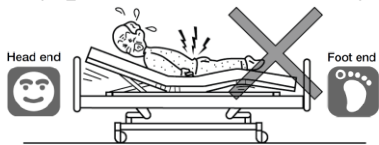

- There is a risk of injury caused by extending the joints backward.

■ Use the bed according to the patient's medical condition.

- The bed operations may adversely affect the medical conditions of patients with specific symptoms. Before the patient or a family member operates the bed, make sure that the physicians or nurses explain details given in the instruction manual and proper usage to suit the patient's medical condition.

■ Do not perform the bed operation such as raising the back or knee section base with a restraint belt attached to the main frame.

- The patient's body may be squeezed resulting in injury or the bed may get damaged or deformed.
- If a patient or family can come into contact with the handheld controller, the side-rail integrated panel or the patient control panel, limit the operation by either of the following methods in order to prevent accidents caused by incorrect operation.
 - Rotate the switch on the Lock-out switch to the lock position to disable the handheld controller operation.
 - Press the Lock button on the side-rail integrated panel to disable the side-rail integrated panel and the patient control panel operation.
 - Unplug the power plug.

■ Do not use the bed for infants or small children.

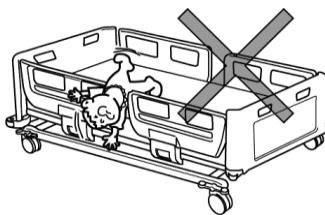

- This product is not designed for infants or small children. There is a risk of injury caused by the infant or small child getting caught in gap between the side-rails.
- There is a risk that infants may fall off the bed through the gap between the side-rails, even when the side-rails are used.

■ Do not stand on the bed.



- There is a risk of injury caused by the person falling off the bed or falling down, or the bed could be damaged or deformed. Pay close attention to children.

2 SAFETY PRECAUTIONS

WARNING

- Do not spill liquids on the bed.
 - Do not spill liquids on the bed's electrical components, such as the motors, handheld controller. This could cause an electric shock due to a short circuit or product failure. If liquids are spilt accidentally, disconnect the power plug from the power outlet and contact Paramount Bed or your distributor.
- Make sure that there is nothing in the board attachment holes or the option attachment holes when mounting the boards or the accessories.
 - If there are obstacles in the attachment holes, you cannot mount the boards or the accessories, and the patient may fall off the bed or get caught in the gap, resulting in injury.
- Do not use a mobile phone or other wireless device in the vicinity of the bed.
 - This could cause the bed to malfunction or affect other medical equipment.
- Do not attach a restraint belt to boards or side-rails.
 - The belt could unexpectedly come off, resulting in injury, or the bed could get damaged or deformed.
- When attaching the restraint belt to mattress base, put it through the mounting bracket of the mattress base.
 - If the restraint belt is attached to something other than the mounting bracket, the belt could unexpectedly come off, resulting injury, or the bed could be damaged or deformed.
- Do not combine the bed with products other than the suitable products specified by Paramount Bed.
 - For options directly attached to the bed such as mattresses, use suitable products specified by Paramount Bed. Using other products may create unintended gaps, cause interference between products, or lower the product safety, which may result in injury or operational failure.
- Keep the bed away from fire.
 - Do not use thermal appliances such as heaters near the bed. Otherwise, the bed may be damaged or deformed, or even catch fire.
- During operation, be careful not to trap the tubes.
 - It may cause damage to the tubes and devices or be trapped within the moving bed parts, resulting in injury.
- When moving the bed, watch your step.
 - Your leg may bump into the caster operation pedal or your foot may get caught by a caster, resulting in injury.
- Lock the casters at all times except when moving the bed.
 - The bed may move when a patient gets into or out of the bed, resulting in an unexpected injury. When moving the bed, operate the caster operation pedal and unlock the casters.
- Do not step on the caster operation pedal.
 - There is a risk of injury due to falling or damage to the bed.

2 SAFETY PRECAUTIONS

WARNING

■ Do not trip over the power cable or the handheld controller cable.

- The power plug or cables may get damaged and short circuit, resulting in electric shock or fire.
- There is a risk of injury caused by the patient falling down.

■ Do not run cables (such as the power cable) of the bed or other electrical appliances under the bed.

- The cables may get caught in casters or moving parts and become damaged and short circuit, resulting in electric shock or fire.

■ Do not apply excessive force to the power plug.

- There is a risk of electric shock or a fire due to a short circuit.

■ Do not allow dust to accumulate on the power plug pins.



- Dust on the power plug can absorb moisture and conduct electricity, causing a short circuit and possibly resulting in electric shock or fire.
- Wipe away any dust accumulating on the surface of the power plug using a dry cloth.

■ Always unplug the power plug before cleaning.

- There is a risk of injury due to accidental operation or electric shock due to a short circuit.

■ Do not insert or remove the power plug with wet hands.

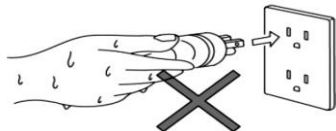

- There is a risk of electric shock or product failure due to a short circuit.

■ Do not damage cables (such as the power cable).

- Damage to the cables may cause electric shock or fire due to a short circuit.
 - Be careful not to allow cables to get caught in the moving parts of the bed.
 - Be careful not to place heavy objects on the cables or apply excessive force to them.
 - Do not run over cables with the bed.
- Request repair (or replacement) of damaged cables.

■ Do not bump or damage electrical parts such as the handheld controller.

- The bed may malfunction, resulting in injury, and there is a risk of electric shock or fire due to a short circuit.
- This may cause operational failure.
- Request repair (or replacement) of a damaged handheld controller.

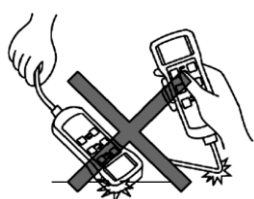

Hook damage

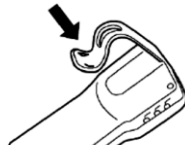

Scratched cable

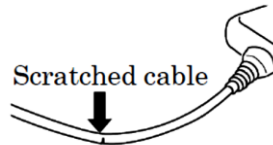

2 SAFETY PRECAUTIONS

WARNING

- When disconnecting the power plug, hold the power plug body to disconnect.
 - When holding onto only the power cable and pulling it to disconnect the plug from the outlet, the cable could be damaged and there is a risk of electric shock or fire due to a short circuit.
- Always disconnect the power plug for the bed from the power outlet when using electronic medical equipment.
 - Using the bed in conjunction with electronic medical equipment (e.g. microwave or ultrashortwave medical equipment) may cause operational failure or malfunction.
 - Check for safety considerations before using the bed in conjunction with other medical equipment.
- Do not repair or modify the product or its components.
 - This may create unintended gaps or may cause abnormal operation, resulting in injury.
- Inspect the bed regularly.
 - The product exhibits wear and deterioration according to the frequency and conditions of use. Inspect for loose parts, the operation of moving parts on the bed, and the presence of damage regularly. There is a risk of unexpected injury.
- Beds damaged in accidents must be inspected and repaired before being reused.
 - Beds damaged in earthquakes, fires, or floods or other incidents must be inspected and repaired by Paramount bed or your distributor. Otherwise, there is a risk of electric shock or fire due to short circuit or current leakage from electrical parts, or injury due to malfunctioning caused by deformation of the bed.
- The bed should not be used by two or more persons.
 - This bed is designed for use by one person. When used by two or more persons, the bed could be damaged, resulting in injury. User's maximum weight is 195kg.
If a physician, nurse, or caregiver needs to get on the bed for a short time, confirm the following conditions beforehand.
 - The total weight of the person to get on the bed must not exceed user's maximum weight.
 - The mattress base has been lowered all the way, and is flat.
- Do not apply more than the safe working load on the bed.
 - The bed could be damaged, resulting in injury. The safe working load of this bed is 2250N (230kgf). The safe working load is the maximum load with which the bed can be operated and is the total load of the user's weight and incidental items including the mattress and options.
- Do not place the bed on the inclination which angle is 6 degree or more.
 - The bed may tip over, resulting in an injury.
- Do not spray a spray-type insecticide directly on the bed.
 - There is a risk that the solvents contained in insecticide may damage, discolor, or dissolve casters or other resin parts of the bed. Check for damage caused by insecticide because damaged or dissolved parts may cause an unexpected injury.
- Do not use electrically powered beds in the presence of flammable gases.
 - There is a risk of explosion.

2 SAFETY PRECAUTIONS

CAUTION

- When performing the height adjustment or inclination angle adjustment, pay attention not to hit the wall, beam, or power outlet on the wall.

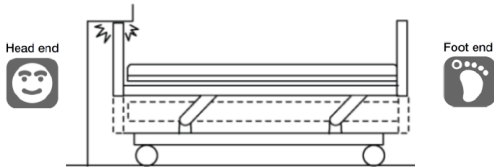

- The bed or wall may be damaged or deformed. Make sure that the bed does not hit the wall, beam, or power plug during the height adjustment or inclination angle adjustment.

- When setting up the bed, make sure that there is at least 20 cm clearance from the wall.

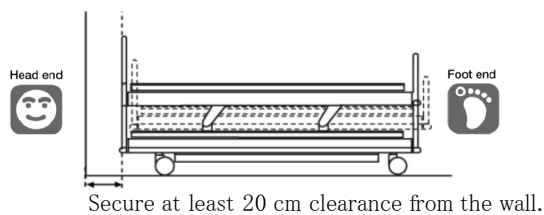

- The main frame moves back and forth during the height adjustment or inclination angle adjustment and could hit the wall, causing damage or deformation of the bed.

- Do not get on the mattress base when it is raised.

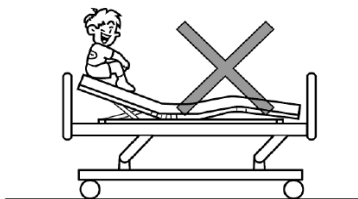

- It applies excessive force to the support of the mattress base, causing damage or deformation.

- Check around the bed before operating the bed.

- The bed operations may damage objects located around the bed, or may cause the bed to be damaged or deformed.

- Make sure that the board stoppers are properly locked.

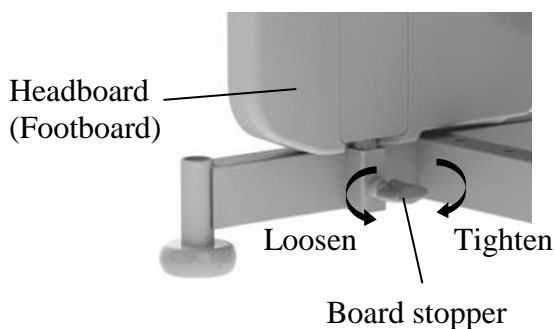

- If the board stoppers are not locked properly, the board may suddenly disengage when a staff pushes (pulls) the board to move the bed or a patient grabs the board to support their body, resulting in injury due to the patient losing balance and falling down.

- Do not hold the side-rails to move the bed.

- It applies excessive force to the side-rails, causing damage or deformation.

- Pay attention to the board and devices that install at the attachment holes during tilt angle adjustment.

- During tilt angle adjustment, pay attention the board and accessories attachment holes will become tilted at an angle, which may cause equipment to drop, leading to injury as well as damage and deformity to the equipment.

2 SAFETY PRECAUTIONS

CAUTION

- Avoid transporting over uneven floors.

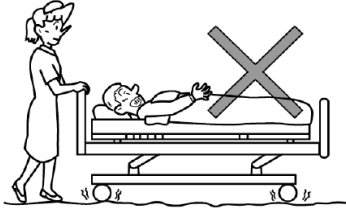

- This may cause damage to the bed, or deformation or failure of the bed. If moving on uneven floor is necessary, move the bed as slow as possible.

- The handheld controller must be attached to a suitable bed.

- If it is attached to an unsuitable bed, the bed could operate unexpectedly, resulting in injury or bed failure.
- Even though the bed is the same series, the suitable handheld controller may be different due to a specification changes. Before attaching the handheld controller to the bed, check that the part number and shape of the handheld controller are the same as those of the bed.

- When using a patient lifter, do not use the leg part height is more than 140mm.

- The leg part of the patient lifter cannot be inserted under the bed and the patient lifter cannot be used safely.

- When using a patient lifter, it can be used in the area as shown in the picture.

- Do not use the patient lifter in the other area because it may damage or deform.

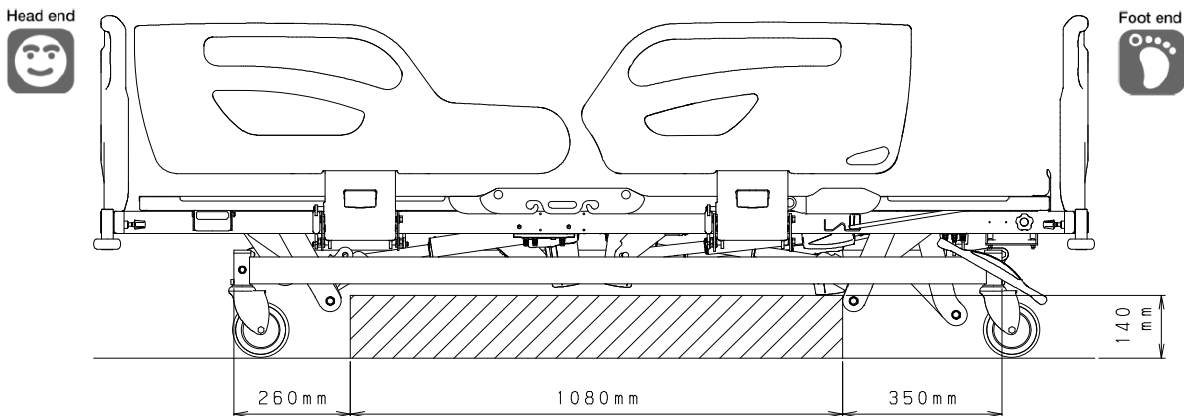

- The angle of the leg section base must be adjusted by at least two persons from both sides of the bed.

- If only one person attempts to adjust the angle, the person may get caught between the leg section base and main frame, resulting in injury.

3 INSTALLATION

■ To avoid possible malfunctions, do not install the bed in the following

- Locations expose to direct sunlight
- Locations near heat sources such as a stove or heater
- Location which is heavily electrically charged such as near an MRI
- Location that has a high oxygen level
- Locations exposed to excessive amounts of water vapor or oil vapor
- Location that tend to be exposed to high temperatures, high humidity, low temperatures or dry conditions

※ The optimum ambient conditions for the bed are as follows.

Temperature 5°C to 40°C / Humidity 20%RH to 90%RH at 30°C / Atmospheric pressure 700hPa to 1060hPa.

- Locaitons with large amount of dust, smoke, salt, sulfur, or corrosive substances
- Locations with poor ventilation
- Locations exposed to vibrations or shocks (including during transportaion)
- Locations where the floor is not strong enough
- Locations where the floor is not level

CAUTION

■ When performing the height adjustment or inclination angle adjustment, pay attention not to hit the wall, beam, or power outlet on the wall.

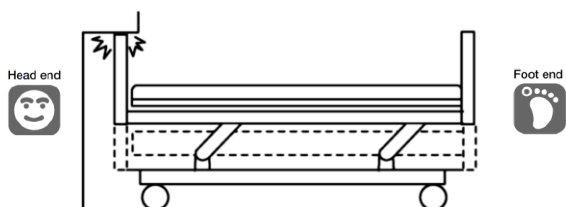

- The bed or wall may be damaged or deformed. Make sure that the bed does not hit the wall, beam, or power plug during the height adjustment or inclination angle adjustment.

■ When setting up the bed, make sure that there is at least 20 cm clearance from the wall.

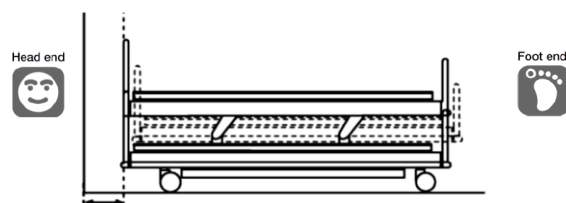

Secure at least 20 cm clearance from the wall.

- The main frame moves back and forth during the height adjustment or inclination angle adjustment and could hit the wall, causing damage or deformation of the bed.

4 ASSEMBLING THE BED

1.Board

WARNING

- Do not attach the board in the wrong way, or the head or neck enters the gap between the board and the side-rail, and there is a risk of injury.
- Do not leave the board detached, or a patient may fall off the bed, resulting in injury.
- Do not detach the headboard when lifting pole is attached, or the head or neck enters the gap between the side-rail and the lifting pole, and there is a risk of injury.

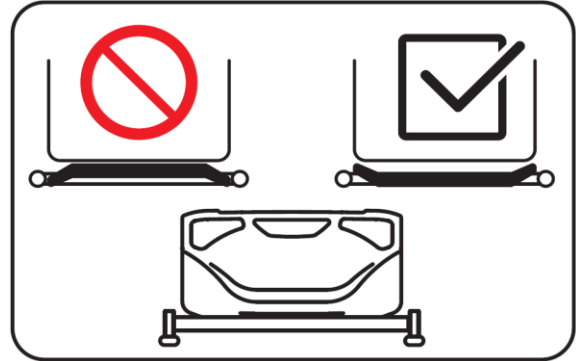

CAUTION

- When attaching the board, make sure that the board stoppers are properly locked. Otherwise, the board may disengage when the bed is moved, resulting in injury due to a fall.
- Do not attach the board to a hole other than the board attachment hole. Attachment could become insufficient and the board could be rattled or come off, resulting in injury.
- When removing the board, do not forcefully lift it while the board is tilted. There is a risk of deformation of the board insertion parts.

- The boards can be attached or detached.

When washing the patient's hair, detach the headboard. When performing lower limb training or giving a foot bath, detach the footboard.

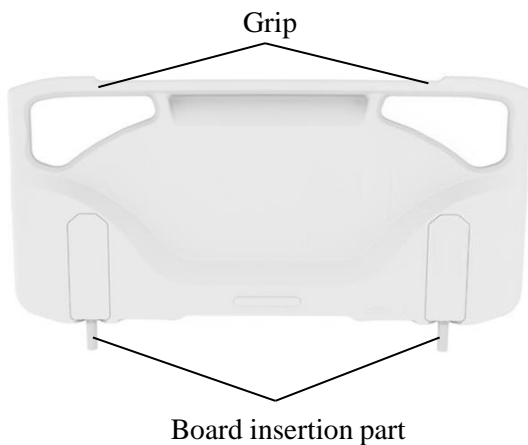

[Attaching]

- ① Loosen the board stoppers on the bed.
- ② Hold the grip of the board to lift it and properly insert the board insertion part into the board attachment hole of the bed.
- ③ Firmly tighten the board stopper to fasten the board.
- ④ Lightly pull up the board and check that the board is locked.

[Detaching]

- ① Loosen the board stoppers on the bed.
- ② Hold the grip of the board and pull it directly up.

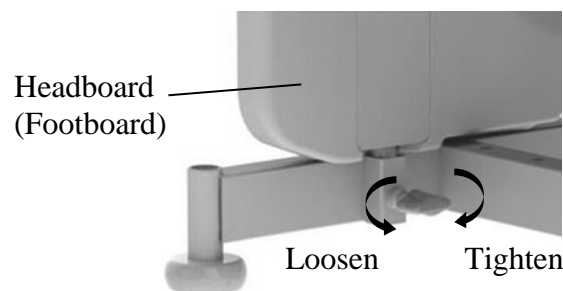
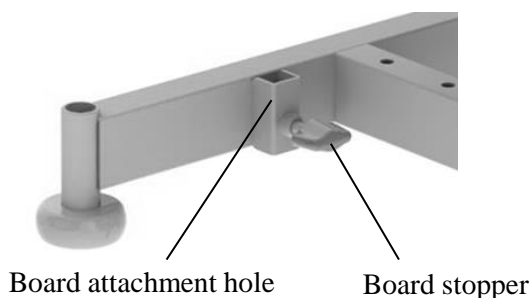

4 ASSEMBLING THE BED

2. Mattress stopper (CA-54380 / CA-53380 only)

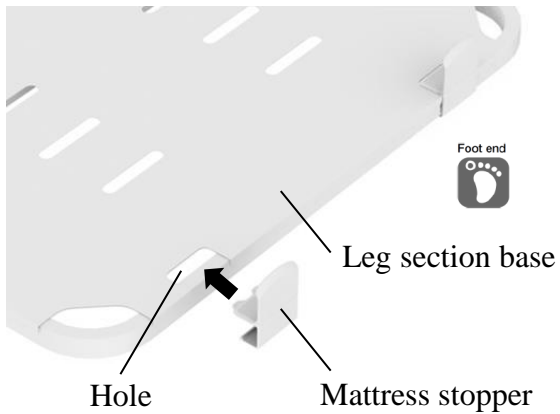

[Attaching the mattress stopper]

- ① Insert the mattress stoppers into the holes of the leg section base.
- ② Push the mattress stoppers inwardly.
- ③ Lightly push the mattress stoppers from inside to outside to make sure they are attached properly.

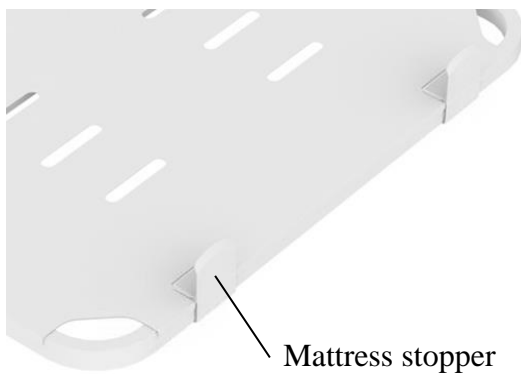

5 CONNECTING TO THE POWER SUPPLY

1. Power outlets

WARNING

- Do not connect multiple cables to a single power outlet. If other electrical equipment is plugged into a power outlet or an extension cable and its rated capacity is exceeded, it could cause the cable or plug to overheat, resulting in fire.
- Make sure the plug is easily accessible so it can be disconnected quickly in an emergency.

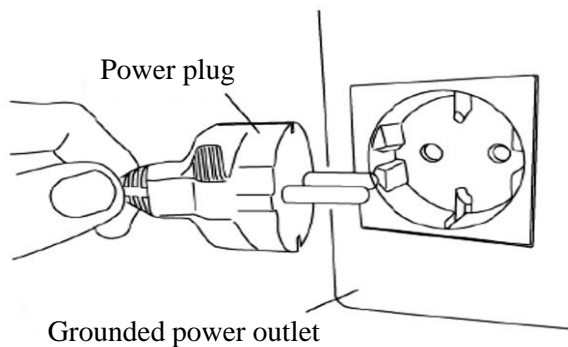
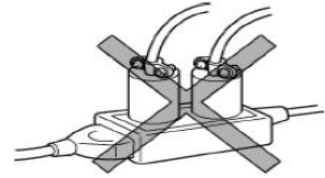

- Each Bed should be plugged into a separate, appropriately wired, grounded power outlet and the power plug must be properly inserted into the outlet.

2. Cable storage

- Wind the power cable onto the main frame when moving the bed.

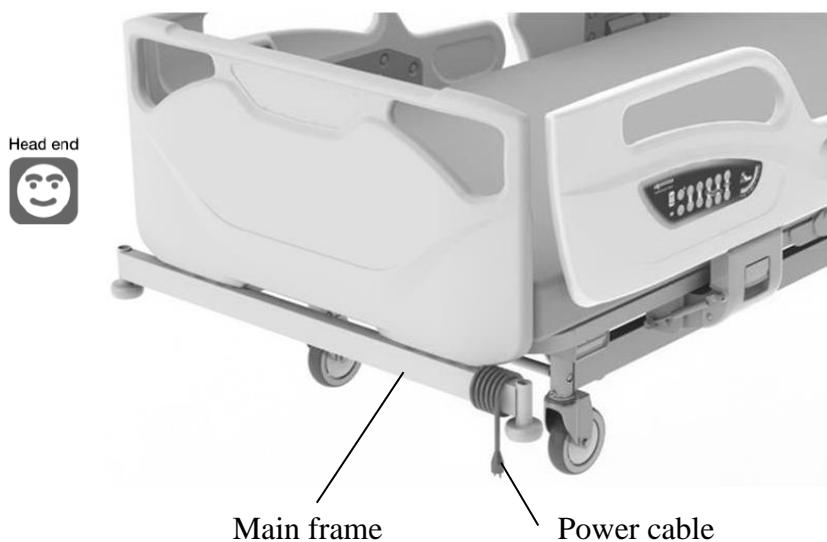

6 OPERATION PROCEDURES

1. Operation over view

WARNING

- When performing a position operation, check that the patient's head, arms, feet, or other body parts have not entered the gap of the side-rails, or the space between the back section base and the frame; There is a risk of getting caught, resulting in injury.
- When performing the height adjustment or inclination angle adjustment with the side-rail lowered, do not place legs under the side-rail. There is a risk of getting caught, resulting in injury.
- Do not allow the patient to get into or out of the bed while the bed is in the chair position. There is a risk of injury caused by the patient falling down.
- Setting the bed to the chair position must only be performed under the observation of a physician or a nurse.



- The angle of the back and knee section bases and the bed height and inclination angle (Trendelenburg and Reverse Trendelenburg) can be electrically adjusted with no increments.
- The angle of the leg section base can be manually adjusted in two levels.

Back raise

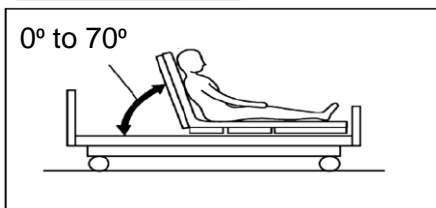

- The angle of the back section base can be adjusted electrically from an angle of 0° to 70°.

Knee raise

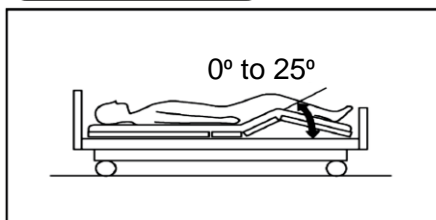

- The angle of the knee section base can be adjusted electrically from an angle of 0° to 25°.

Height adjustment

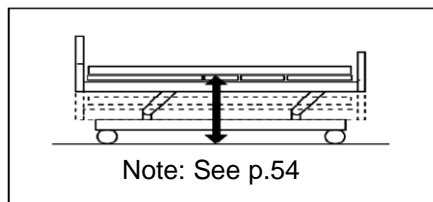

- The height from the floor to the mattress base surface can be adjusted electrically.

6 OPERATION PROCEDURE

Trendelenburg

※4 motors type only

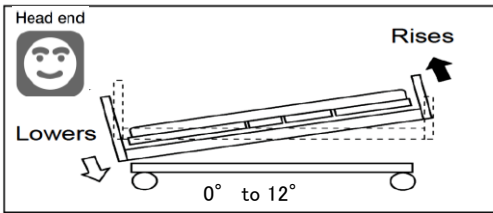

- The head end of the bed can be lowered.
The angle can be adjusted electrically up to 12°.

Reverse Trendelenburg

※4 motors type only

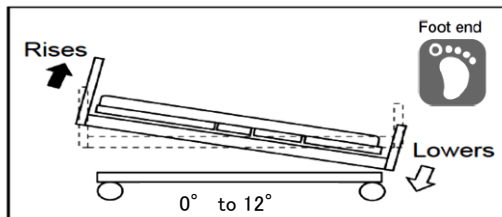

- The head end of the bed can be raised.
The angle can be adjusted electrically up to 12°.

Chair position

※4 motors type only

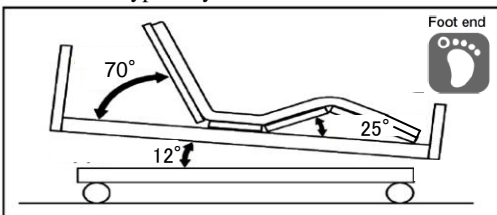

- As shown in the picture on the left, a near seated posture (chair position) can be created.

Flat function

※4 motors type only

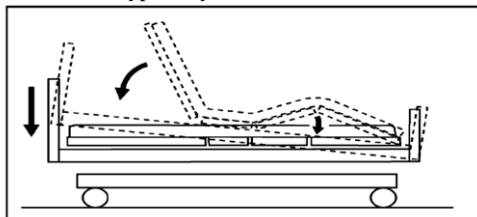

- The angle of the back section base and knee section base and inclination angle of the bed can be adjusted to 0° (flat).

6 OPERATION PROCEDURE

2. Handheld controller

WARNING

● Do not allow the bed to be operated by a child aged 12 or under, or someone deemed incapable of comprehending the operation of the bed. If a child aged 12 or under, or someone deemed incapable of comprehending the operation (such as persons with dementia) operates the handheld controller by themselves, there is a risk of unexpected injury such as the body getting caught in the bed by accident. If such person can come into contact with the handheld controller, unplug the power plug or rotate the switch on the Lock-out switch to the lock position in order to prevent accidents caused by incorrect operation.

● The angle of the back section base, the angle of the knee section base, the bed height and the inclination angle of the entire bed can be smoothly adjusted with no increments by using the handheld controller.

Pressing the button adjusts the bed, and releasing the button stops adjustment, allowing you to adjust the bed to the desired position. Press the [↑] to raise the desired section and press [↓] button to lower the desired section.



Back raise adjustment buttons

● The back section base angle can be adjusted.



Knee raise adjustment buttons

● The knee section base angle can be adjusted.



Hi-lo adjustment buttons

● The bed height can be adjusted.



Chair position / Flat position buttons



● Chair position button : The back section base and the knee section base can be raised simultaneously, and then the bed position is moved into Chair position.

● Flat position button : The bed position is moved into Flat position.



Trendelenburg / Reverse trendelenburg (TR / RTR) adjustment buttons

● The inclination angle of the entire bed can be adjusted.



NOTE!

- Pressing two or more buttons simultaneously stops the adjustment. If you stop the adjustment by pressing two or more buttons, remove your hands from all buttons and then perform the adjustment again.
- When the TR/RTR button is selected with the head end raised and the DOWN button is pressed, the movement stops when the bed becomes flat. To incline the bed further, continue to press the DOWN button for more than 2 seconds.
- When the TR/RTR button is selected with the head end lowered and the UP button is pressed, the movement stops when the bed becomes flat. To incline the bed further, continue to press the UP button for more than 2 seconds.
- If the bed is used continuously, the bed cannot be operated for protecting electrical parts from overheating. In that case, disconnect the power cable and the battery cable, and leave the bed for more 1 hour. After that, connect the power cable and the battery cable, and press the Hi-lo adjustment UP[↑] and DOWN[↓] buttons simultaneously for more 5 seconds to reset the protect condition.

6 OPERATION PROCEDURES

CAUTION

- Do not drop the handheld controller or pull the cable. The handheld controller may get damaged or deformed, causing it to operate incorrectly. Request repair (or replacement) of a damaged handheld controller, if necessary.



- The handheld controller must be properly set in the storage position or hung the side-rail using one hook with the buttons facing out. Otherwise, when the bed or side-rail is operated, buttons on the handheld controller could be pushed and the bed could be operated unexpectedly, causing damage to the handheld controller.

- The Lock-out switch can be used to disable the handheld controller operation. The Lock-out switch is located on right side of the bed, below the hip section base.



Lock position

[Locking the handheld controller operation]

Rotate the switch to the lock position.



Unlock position

[Unlocking the handheld controller operation]

Rotate the switch to the unlock position.

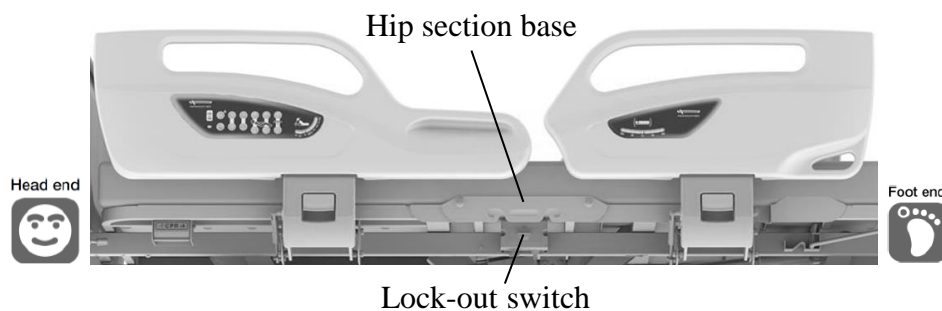

- Store the handheld controller in the handheld controller storage position on the side-rail near to the headboard.

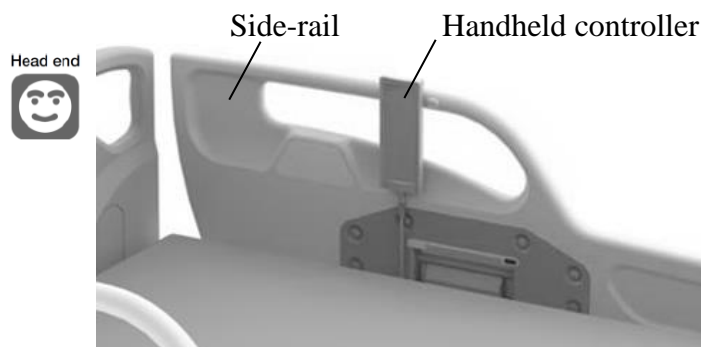

6 OPERATION PROCEDURE

3. Side-rail integrated panel

WARNING

● Do not allow persons other than doctors and nurses to operate the side-rail integrated panel. There is a risk of injury due to incorrect operation.

● The side-rail integrated panel includes switches for the following bed operations that are performed by doctors and nurses.

● The side-rail integrated panel is available in both side-rails near to the headboard, on the right and left side.

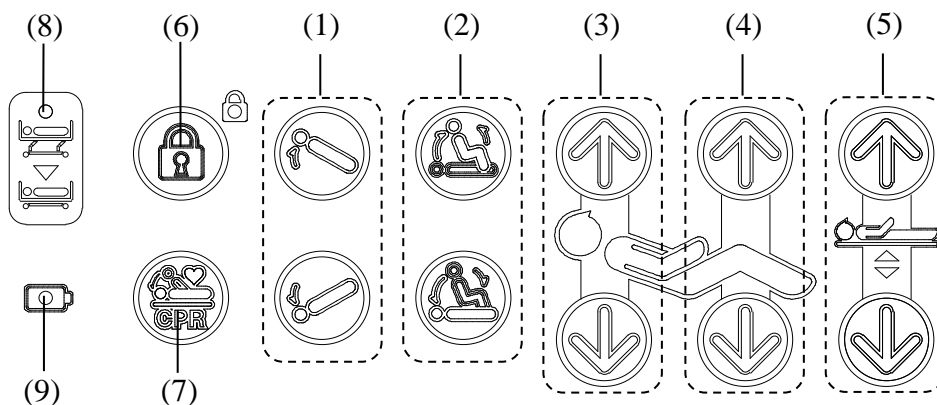

(1) Trendelenburg / Reverse Trendelenburg (TR / RTR) adjustment buttons
The inclination angle of the entire bed can be adjusted.



(2) Chair position / Flat position buttons

- Chair position button : The back section base and the knee section base can be raised simultaneously, and then the bed position is moved into Chair position.
- Flat position button : The bed position is moved into Flat position.



(3) Back raise adjustment buttons

The back section base angle can be adjusted.



(4) Knee raise adjustment buttons

The knee section base angle can be adjusted.



(5) Hi-lo adjustment buttons

The bed height can be adjusted.



(6) Lock button

Press the button to switch the side-rail integrated panel and the patient control panel lock function ON or OFF.

If the lamp next to the button lights up in green, it indicates that the lock function is ON.



(7) Electric CPR button

Press the button to move the back and knee section bases and inclination bed to flat.

6 OPERATION PROCEDURES

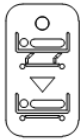

(8) Low height indicator

- OFF : Bed height is at the lowest position.
- Orange : Bed height is not at the lowest position.



(9) Power indicator

[When the battery is connected.]

- Green light : Battery is charged.
The bed can be operated.
- Green flashing : Battery is not fully charged yet.
The bed can be operated.
- OFF : Weak battery, need to charge.
The bed cannot be operated.

[When the battery is not connected.]

- Green light : The power cable is connected.
The bed can be operated.
- OFF : The power cable is not connected.
The bed cannot be operated.



- Pressing two or more buttons simultaneously stops the adjustment. If you stop the adjustment by pressing two or more buttons, remove your hands from all buttons and then perform the adjustment again.
- When the TR/RTR button is selected with the head end raised and the DOWN button is pressed, the movement stops when the bed becomes flat. To incline the bed further, continue to press the DOWN button for more than 2 seconds.
- When the TR/RTR button is selected with the head end lowered and the UP button is pressed, the movement stops when the bed becomes flat. To incline the bed further, continue to press the UP button for more than 2 seconds.
- If the bed is used continuously, the bed cannot be operated for protecting electrical parts from overheating. In that case, disconnect the power cable and the battery cable, and leave the bed for more 1 hour. After that, connect the power cable and the battery cable, and press the Hi-lo adjustment UP[↑] and DOWN[↓] buttons simultaneously for more 5 seconds to reset the protect condition.
- If the Electric CPR button is pressed, at first the back section base and inclination bed move to flat simultaneously. After the inclination angle of the entire bed is flat, the knee section base moves to flat.
- When the power cable is not connected, all indicators go out 2 minutes after the last button has been used. If any button is pressed, the indicators light up again.

4. Patient control panel

WARNING

- Do not allow the bed to be operated by a child aged 12 or under, or someone deemed incapable of comprehending the operation of the bed. If a child aged 12 or under, or someone deemed incapable of comprehending the operation (such as persons with dementia) operates the side-rail integrated panel or the patient control panel by themselves, there is a risk of unexpected injury such as the body getting caught in the bed by accident. If such person can come into contact with the side-rail integrated panel or the patient control panel, unplug the power plug or press the lock button on the side-rail integrated panel to disable the side-rail integrated panel and the patient control panel operation in order to prevent accidents caused by incorrect operation.
- The patient control panel is available in both side-rails near to the headboard, on the right and left side.
- The angle of the back section base and the knee section base can be smoothly adjusted with no increments by using the patient control panel.
Pressing the button adjusts the bed, and releasing the button stops adjustment, allowing you to adjust the bed to the desired position. Press the [↑] to raise the desired section and press [↓] button to lower the desired section.

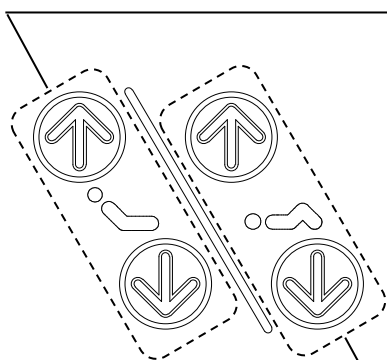

Back raise adjustment buttons

- The back section base angle can be adjusted.

Knee raise adjustment buttons

- The knee section base angle can be adjusted.



- Pressing two or more buttons simultaneously stops adjustment. If you stop adjustment by pressing two or more buttons, remove your hands from all buttons and then perform adjustment again.

6 OPERATION PROCEDURES

5. Emergency CPR (back-lowering) function

WARNING

- When using the emergency CPR function, make sure that the patient's and/or user's head, arms, feet or other body parts have not entered the gap between the back section base and the frame. There is a risk of getting caught, resulting in injury.

CAUTION

- Do not stop the back-lowering operation halfway through. This may cause malfunction of the bed.
- Do not use the emergency CPR lever to raise back section base.
- Do not operate the bed while holding on to the emergency CPR lever.

- In case of an emergency or a power failure, the raised back section base can be quickly returned to flat status.

Head end

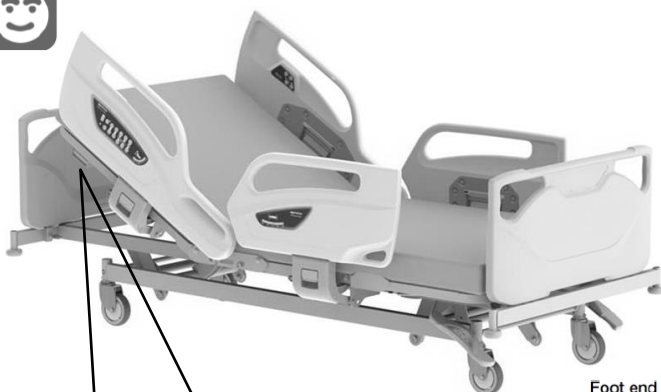

Foot end



<Emergency CPR function procedure>

- ① Place one hand on the side of the back section base and pull the emergency CPR lever. Levers are located at both sides of the bed under the back section base and either lever can be used.
- ② Keep pulling the lever until the back section base returns to flat status.

Back section base

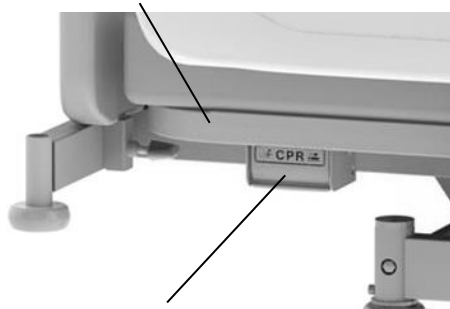

Emergency CPR lever



- After operating emergency CPR function, firstly press the [↓] button of the back raise adjustment buttons on the handheld controller or the side-rail integrated panel for more than 5 seconds in power on status.

6 OPERATION PROCEDURE

6. Adjusting the angle of the leg section base

CAUTION

- The angle of the leg section base must be adjusted by at least two persons from both sides of the bed. If only one person attempts to adjust the angle, the person may get caught between the leg section base and main frame, resulting in injury.

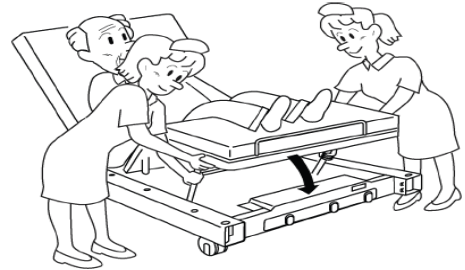

- The angle of the leg section base can be manually adjusted in two levels.
 - Normally, the leg section base comes to the position (b) when the knee section base is raised.
 - Adjustment to the position (a) should be performed when the knee section base is raised.
 - When adjusting to the position (a), hold the end of the leg section base and pull it up, lift the end of the stay up. When the end of the stay comes to the position (A), lower the leg section base slowly.
 - When adjusting to the position (b), hold the end of the leg section base and pull it up. When the end of the stay comes to the position (B), lower the leg section base slowly.

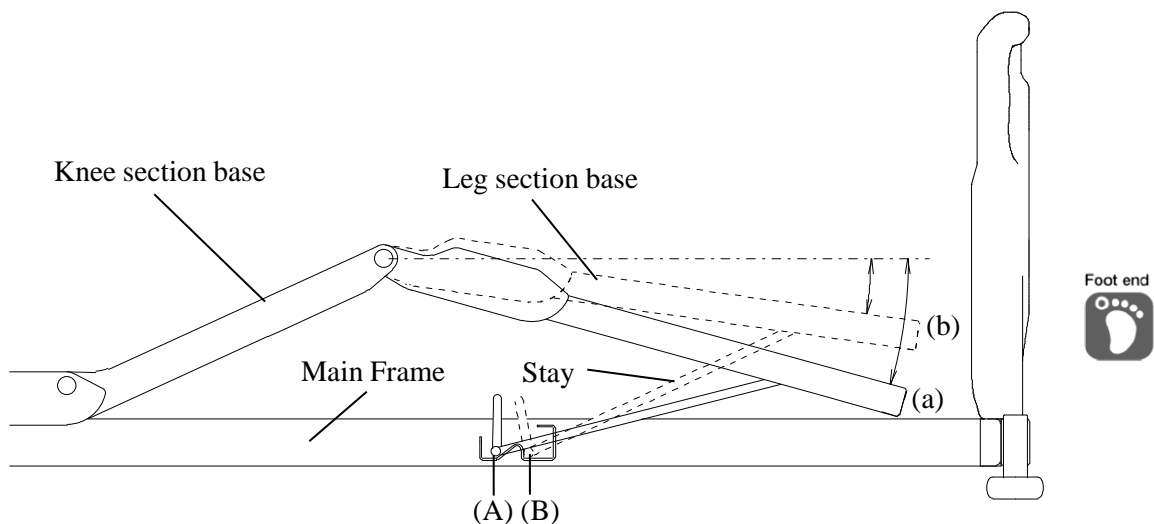

6 OPERATION PROCEDURES

7. Casters

WARNING

- Lock the casters at all times except when moving the bed. The bed may move when a patient gets into or out of the bed, resulting in an unexpected injury.

CAUTION

- Do not attempt to forcibly move the bed when the casters are locked (fixed), as doing so will cause malfunctions.

<Total locking system>

- The casters can be set to either of the positions below by operating the caster operation pedal.

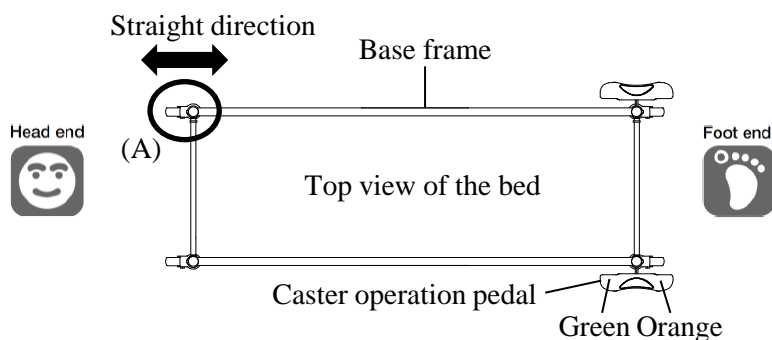

① Locking the four wheels (Lock position)

Depress the orange pedal to lock swiveling and rotation of the four wheels.

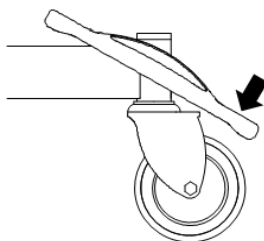

② Unlocking the four wheels (Free position)

Returning the pedal to the horizontal position unlocks the four wheels, allowing them to swivel and rotate.

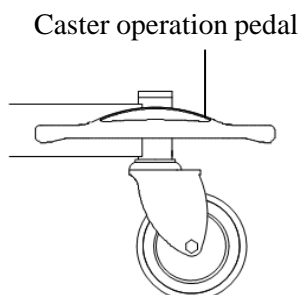

③ Straight-line movement (Steering position)

Depress the green pedal to lock swiveling of the caster (A) (one wheel only) in a straight forward direction. It helps the bed to be moved straight forward easier.

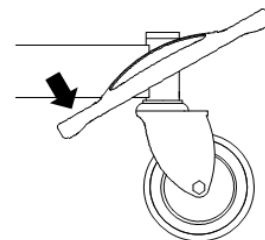

- Inspect the caster regularly. Depending on the frequency of use and the environment, caster will exhibit wear and deterioration. (High-temperature and high-humidity condition may accelerate the deterioration.)

6 OPERATION PROCEDURE

<Individual locking system>

- Use the stopper to lock or unlock the casters.
- Stoppers are on four casters on each corners of the bed. When locking, be sure to lock all casters.
- Depressing the stopper locks the swiveling and rotation of the caster.
- Prior to locking, be sure that the caster is not out of the bed frame.
- To unlock, press the upper part of the stopper with the toe.

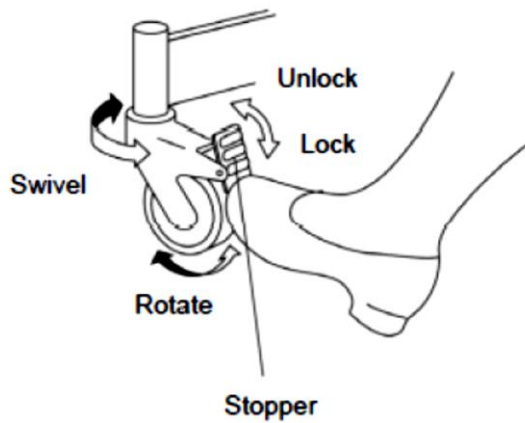

- Inspect the caster regularly. Depending on the frequency of use and the environment, caster will exhibit wear and deterioration. (High-temperature and high-humidity condition may accelerate the deterioration.)

6 OPERATION PROCEDURES

8. Bed side-rails

- There are a total of four side-rails, two side-rails on the left and right, respectively.
- Side-rails prevent the patient from falling off the bed.
- All the side-rails are provided with shock absorber.



Side-rail position when it is raised.



Side-rail position when it is lowered.

Head end

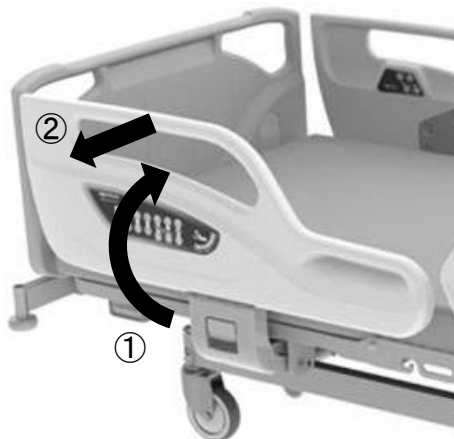

[Raising the side-rails]

- ① Lift the side-rail and push in until it clicks into place.
- ② Pull the side-rail to make sure that the side-rail is locked.

Head end

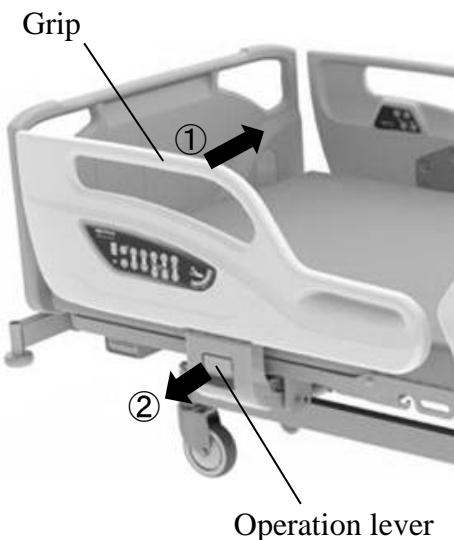

[Lowering the side-rails]

- ① Use one hand to hold the grip of the side-rail and push it.
- ② Use the other hand to pull the operation lever toward you with pushing the side-rail to opposite direction and, while supporting the side-rail, lower the side-rail until it stops.



NOTE!

- The side-rails have a Anti-tampering Lock Feature that keeps the patient safely within bed by preventing the side-rails lock from being released when the patient is leaning against the side-rail. This prevents the patient from falling over when he is attempting to lower the side-rail by himself.

WARNING

- Be careful not to allow any part of the body (especially the head or neck) to enter the gap between the side-rail and the mattress base or the mattress. When the head or neck enters the gap, the patient might not be able to withdraw, and there is a risk of injury.
- Be especially careful to check patients who might act in unexpected ways or cannot maintain their posture independently.
- Do not adjust the side-rails from inside the bed. The side-rails may drop suddenly and there is a risk of injury caused by a patient falling off the bed.
- Do not let patient lean against the side-rail while it is raised. The patient may lose a balance and there is a risk of injury caused by a patient falling off the bed.
- Do not place legs on the side-rail while it is lowered. The bed could turn over, resulting in injury.
- When raising side-rails, make sure that the side-rails are locked. If the side-rails are not completely locked, they may move unexpectedly, resulting in injury.
- Take care to prevent the intravenous tubes or the drain tubes from getting caught. When operating the side-rails, tubes could get caught between the side-rail and mattress and be damaged, resulting in injury.
- When performing the height adjustment or inclination angle adjustment with the side-rail lowered, do not place legs under the side-rail. There is a risk of getting caught, resulting in injury.
- When operating the side-rails, make sure that the patient's hands or feet have not entered the gap between the side-rail and mattress base. When the hands or feet enter the gap, the patient could get caught in the gap, resulting in injury.
- When operating the side-rail with the back section base raised, operate the side-rail with caution. Depending on the back section base angle, the side-rails may move unexpectedly and there is a risk of injury.

6 OPERATION PROCEDURES

9. Accessory holders

CAUTION

- Do not apply more than 3kg load to the accessory holder. This may cause damage and deformation of the accessory holder.

- Accessory holders are provided on both sides on hip section base and on both side-rails near to the footboard. These holders can be used for hanging the urine bags, etc.



Accessory holders



- Commercially available urine bags may have a different attachment method or dimensions, depending on the manufacturer; use only those bags that are authorized for use with the bed.
- When attaching a urine bag, take care to prevent the bag or tube from getting caught when operating the bed or side-rails.

10. Detaching the hip section base

- The hip section base can be detached to clean the undersurface of the hip section base or maintain the bed.

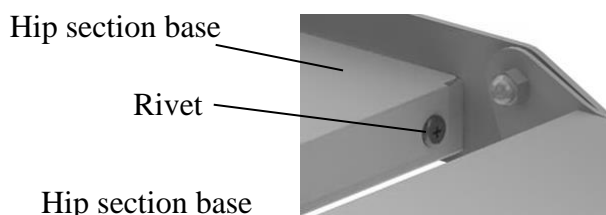

[Detaching the hip section base]

- ① Raise the back section base and the knee section base.
- ② Remove 4 rivets from the hip section base by a screwdriver.
- ③ Lift the hip section base up.

[Attaching the hip section base]

- ① Set the hip section base on the main frame.
- ② Insert 4 rivets into the holes of the hip section base, and push the rivets inwardly.

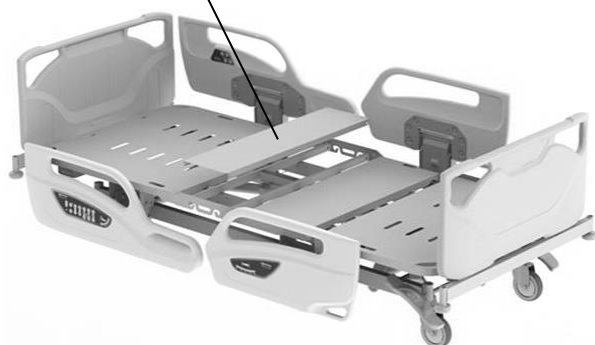

- The undersurface of the back section base, the knee section base and the leg section base can be cleaned by being raised them.

6 OPERATION PROCEDURE

11. Restraint belt mounting holes

WARNING

- Do not perform the bed operation such as raising the back or knee section base with a restraint belt attached to the main frame. The patient's body may be squeezed resulting in injury or the bed may get damaged or deformed.
- When bedmaking or getting into/out the bed, be careful not to insert fingers or any body parts in the mounting brackets. It may result in injury.

■ When using restraint belt, attach the restraint belt to the mounting holes below;

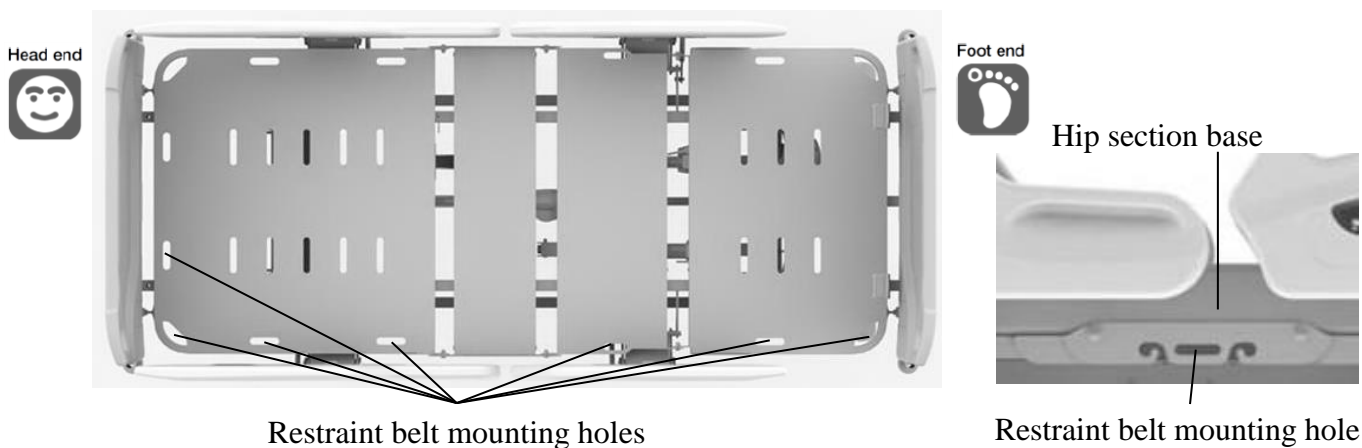

12. Angle indicators

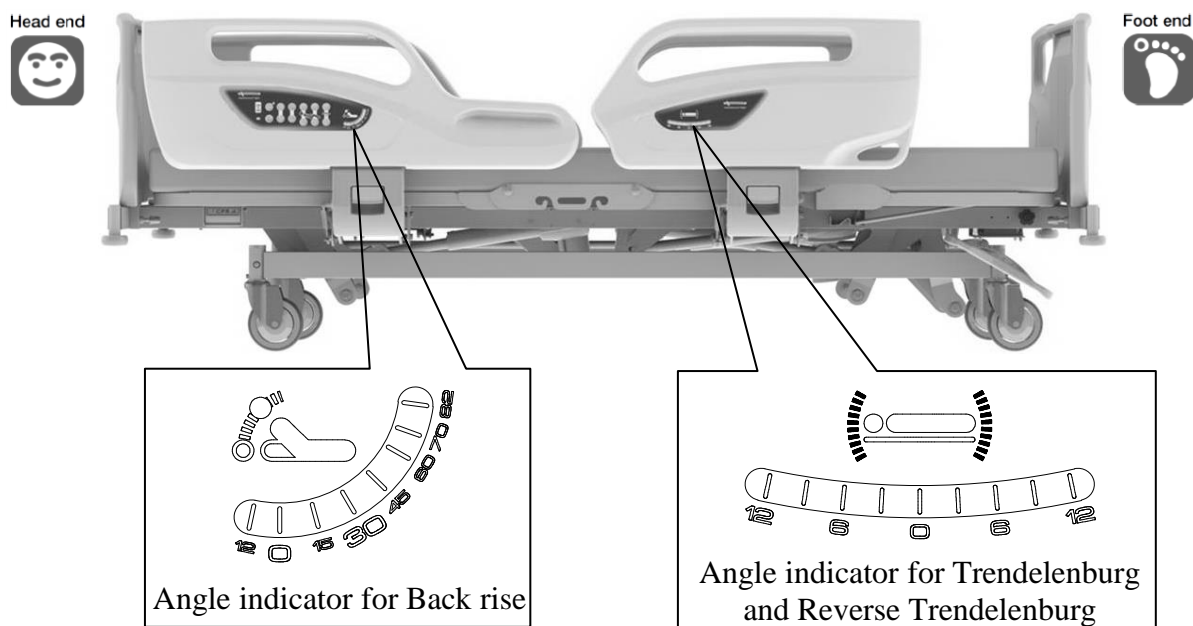

- There are angle indicators for checking back raise angle at the head side of side-rails, and for the checking tilt angle at the foot side of side-rails (4 motors type only). Please use only as a guide.

6 OPERATION PROCEDURES

13. Option attachment holes

- Option attachment holes are at the four corners of the bed.
It can be installed IV pole, oxygen cylinder holder, foot spacer and orthopedic frame attachment.

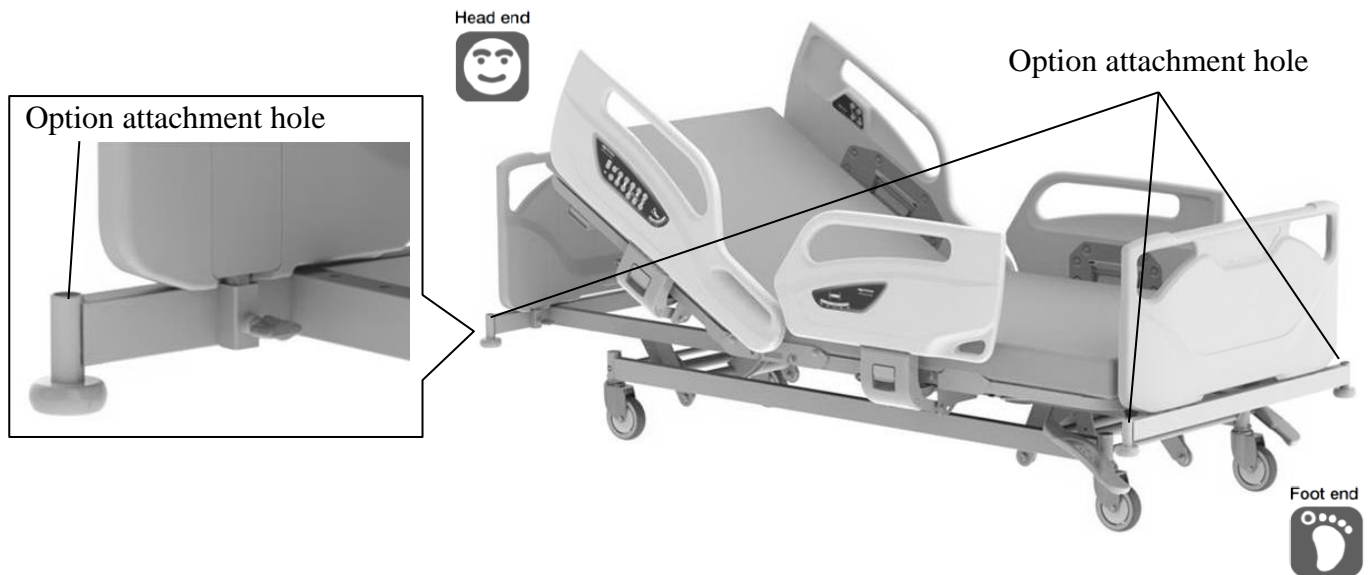

- During tilt angle adjustment, pay attention the board and option attachment holes will become tilted at an angle.

14. Corner bumpers

- Corner bumpers are at the four corners of the bed.
If the bed bumps the walls or equipments of the hospital when moving the bed, the corner bumper can reduce the impact of the collision.

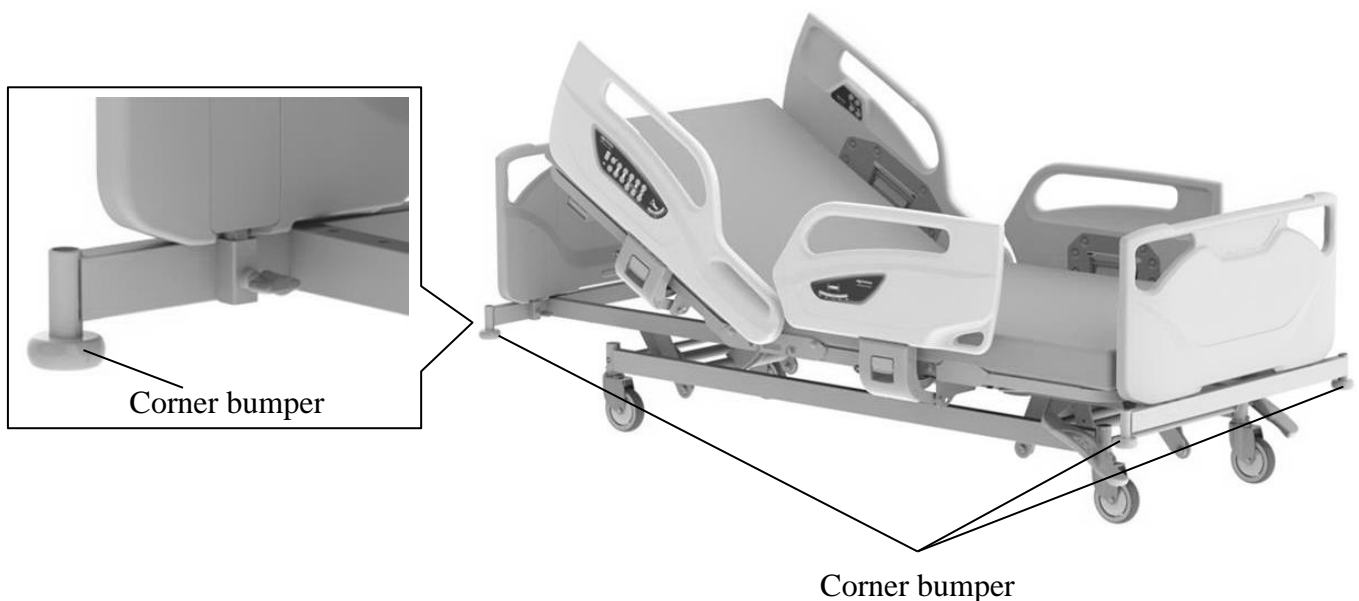

6 OPERATION PROCEDURES

15. Extension frame function

WARNING

- When using the extension frame function, make sure to use a suitable extension mattress. There is a risk that a part of the body may get caught in a gap between the bed and the extension frame, resulting in injury.
- Do not place your hand, foot or knee on the edge of the extension mattress. Since there is no support, you may lose a balance and there is a risk of injury caused by a fall.
- Do not use the extension frame function for patients who cannot maintain their posture independently. There is a risk of injury caused by a patient falling off the bed.

■ The bed can be extended 10cm for tall patients by pulling out the extension frame and adding an extension mattress.

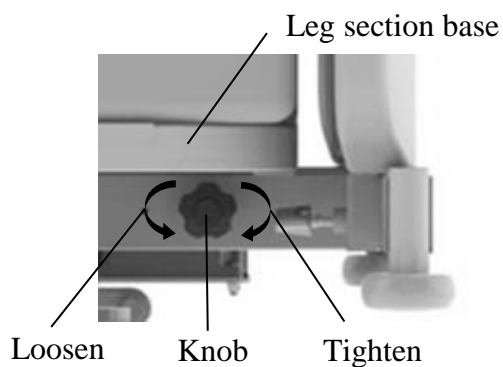

When the extension frame is retracted

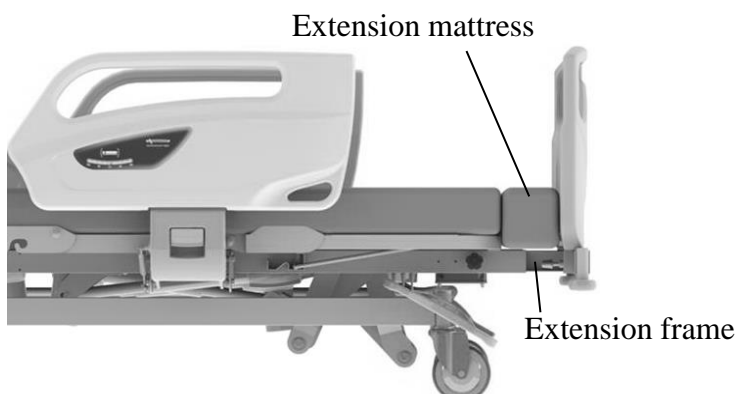

When the extension frame is used

[Pulling out the extension frame]

- ① Loosen the knobs on both side of the bed under the leg section base.
- ② Pull the extension frame out until it stops.
- ③ Tighten the knobs and lightly push the extension frame to make sure that it is properly locked.
- ④ Place the extension mattress on the extension frame.



- When loosening knob, do not rotate it too much. The knob may come off, and may be lost.

[Storing the extension frame]

- ① Remove the extension mattress.
- ② Loosen the knobs on both side of the bed under the leg section base.
- ③ Push the extension frame in until it stops.
- ④ Tighten the knobs and lightly pull the extension frame to make sure that it is properly locked.

16. Battery unit

CAUTION

- Incorrect operation in disregard of the details given below will result in personal injury or damage due to leakage, fire, explosion, electric shock, or rupturing.
 - Do not disassemble the battery case or built-in battery.
 - Do not incinerate the battery unit.
 - Do not recharge the battery other than with suitable control box of the bed.
 - Do not use the battery unit with equipment other than the suitable bed.
 - Do not subject the battery unit to impact.
 - Do not recharge the battery unit or operate the bed with the bed turned upside down.
- When the battery reaches the end of its life span, change it immediately. Continual usage of expired battery may cause leakage or fire. Furthermore, please check time to relace as below;
 - A life of the battery span about 2 or 3 years. The battery indicator flash or turn off the light even the battery charging for more than 12 hours, please change the battery.
 - When you change the battery, please contact Paramount Bed or your distributor.

- The battery is an auxiliary power supply for operating an electrically operated bed when not connected to a power outlet.

[Operating the bed on battery power]

- The bed is powered by the battery when the power plug is not connected to the power outlet or during a power failure.

[Recharging]

- Recharging starts as soon as the bed power plug is plugged into the power outlet.

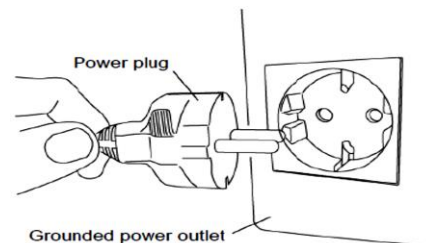

- The battery should be charged (for more than 24 hours) immediately after purchase.

[Battery life]

- The battery is not designed to be recharged after being totally discharged. Repeatedly recharging the battery from zero charge will reduce its operating life. Always recharge the battery after operating the bed on battery power.
- If the bed is equipped with a battery, and the bed is stored for long periods of time, the battery must be full charged every 3 months. It may cause damage to the battery or decrease its life.



- The battery life will vary depending on the usage frequency, usage conditions and storage conditions. Regardless of whether the battery is used, its life will start to drop off after a few years.

6 OPERATION PROCEDURES

15. X-ray cassette tray

CAUTION

- Always disconnect the power plug for the bed from the power outlet when using X-ray apparatus. Using the X-ray apparatus without disconnecting the power plug may cause operational failure or malfunction.
- When placing a cassette to the cassette tray, be careful not to let the cassette fall from the cassette tray. It may caught damage and deformation of the cassette.
- Be sure to use the specified size cassette. Failure to do so could cause the cassette to fall, possibly causing damage or deformation.
- Do not incline the bed if a cassette has been set. The cassette may be ejected, causing injury or damage to the cassette.

■ X-ray imaging using cassette is possible in the area shaded on the figure below.

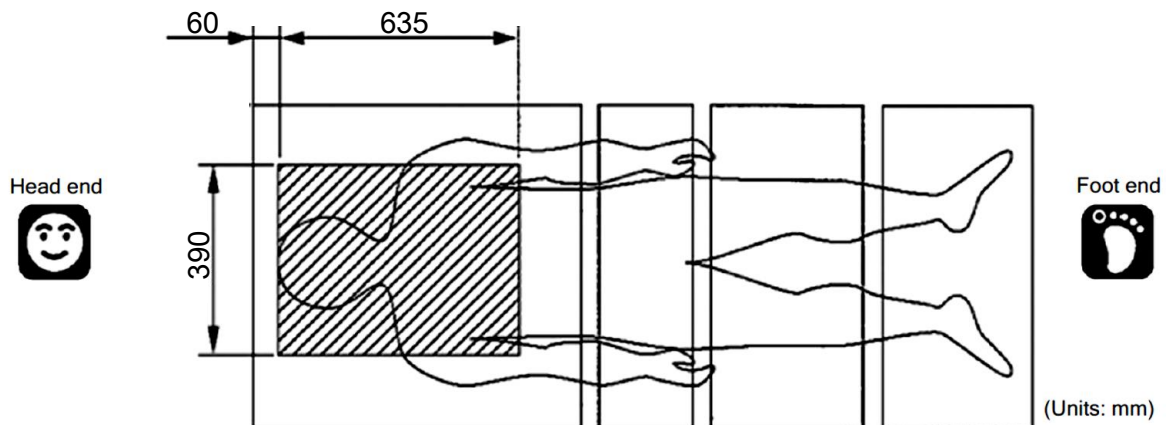

Suitable cassette size

- | | |
|-------------|--------------------------|
| ● Size | 14 × 17" (388mm × 464mm) |
| | 14 × 14" (388mm × 388mm) |
| ● Thickness | 15mm or less |

6 OPERATION PROCEDURE

15. X-ray cassette tray

■ Setting a Cassette.

Set a cassette while the back section base is in horizontal status.

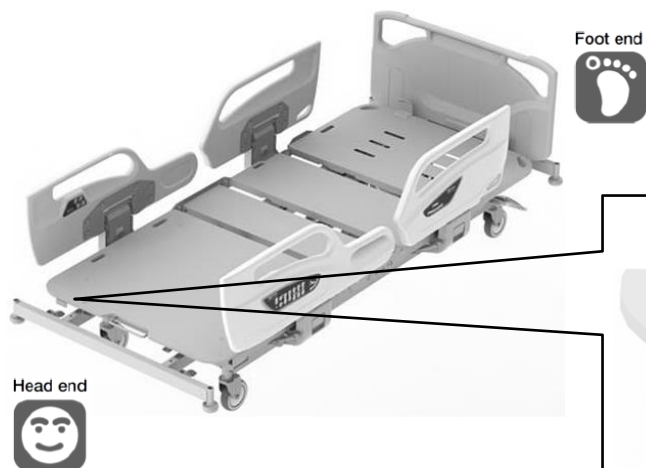

① Detach the headboard.

② Pull the lock lever to unlock it.

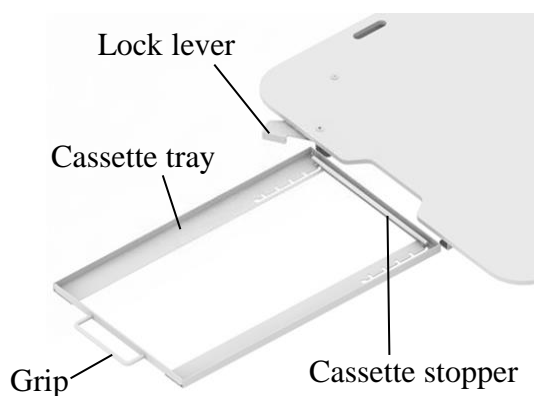
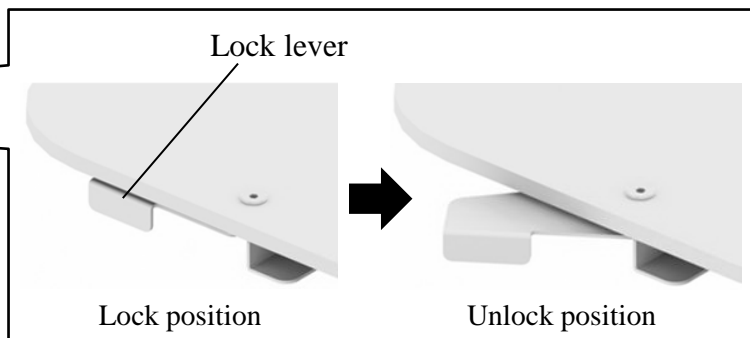

③ Hold the grip and pull the cassette tray all the way out.

④ Set the cassette stopper to the appropriate position. The cassette stopper can be adjusted in 5 levels.

⑤ Set a cassette in the cassette tray.

⑥ Hold the grip and slowly insert the cassette tray all the way to the rear.

⑦ Push the lock lever until it locks into place.

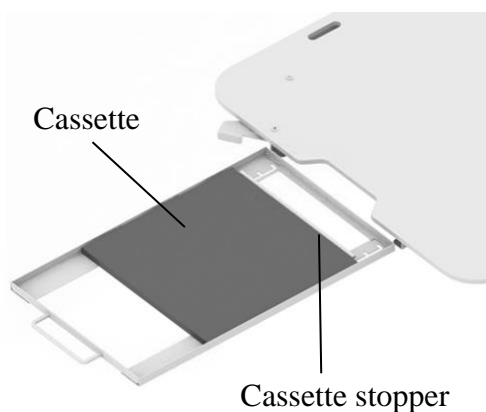

7 MATTRESS (OPTIONAL)

WARNING

- Do not use the bed when the mattress is not placed. The body part (fingers of hands or legs) may get caught in the gap between the mattress bases, in air holes on the mattress base, resulting in injury.
- Be sure to use a mattress of dimensions specified by Paramount Bed, described below. If an unsuitable mattress is used, patients could get caught between the mattress and side rail and get injured. Unsuitable mattresses exert a burden on the bed and may induce a failure.

■ Paramount Bed mattresses with the following dimensions are suitable.

Regular mattress dimension (mm)

Width	Length	Thickness
860	2,000	90 to 150

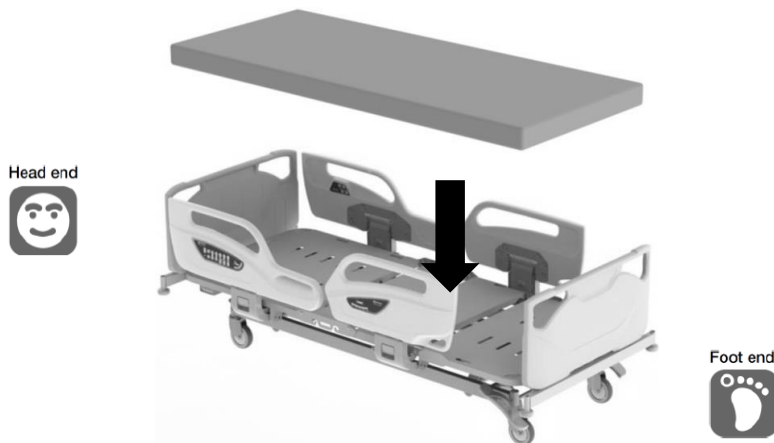

Extension mattress dimension (mm)

Width	Length	Thickness
860	120	120 to 180

■ Compatible Mattresses - Paramount Bed.

CE-025 Series

CE-025341^{*1)} / CE-025341E^{*1)}: 860mm x 2000mm x 100mm

CE-025651^{*1)} / CE-025651E^{*1)}: 860mm x 2000mm x 150mm

CE-025671^{*1)} / CE-025671E^{*1)}: 860mm x 2000mm x 150mm

Extension mattress :

CE-025341-Y^{*1)} / CE-025341-YE^{*1)}: 860mm x 120mm x 130mm

(suitable when used CE-025341^{*1)} / CE-025341E^{*1)})

CE-025651-Y^{*1)} / CE-025651-YE^{*1)}: 860mm x 120mm x 180mm

(suitable when used CE-025651^{*1)} / CE-025651E^{*1)} / CE-025671^{*1)} / CE-025671E^{*1)})

*1) Not available for sale in Europe.



- For more information about mattress specification and any queries, please feel free to contact Paramount Bed or your distributor.

1. Recommended accessories table

WARNING

- Use accessories after confirming that the combination of accessories is correct. Using the bed with the wrong combination of accessories could result in injury or could damage the products. The part number of each accessory is written on the safety label and on the carton box.
- Do not use accessories other than those specified in this instruction manual. This may create unintended gaps or may damage or deform the product, resulting in injury.
- Make sure that there is nothing in the option attachment holes, when mounting the accessories. If there are obstacles in the option attachment holes, you cannot mount the accessories, and the patient may fall off the bed or get caught in the gap, resulting in injury.

IV pole	EC-562
Oxygen cylinder holder (Φ155 mm)	CA-A3212E
Oxygen cylinder holder (Φ115 mm)	CA-A3211E
Lifting pole	CA-A307E
Foot spacer	CA-A3331E
Foot spacer storage	CA-A3332E
Orthopedic frame attachment	CA-A343E
Foot light	MC-5037V
Monitor table	CF-051E
Assist bar	MC-5031V



- Recommend accessories may differ due to specification changes or according to product combinations. For any queries, please feel free to contact Paramount Bed or your distributor.

8 ACCESSORIES

2. IV pole

WARNING

- Do not move the bed with holding the IV pole. The IV pole may break, resulting in an injury.
- Do not use the IV pole as a support to stand up. The IV pole may come off or break, causing an injury due to falling down.
- When using the IV pole, do not put a hand or arm between the mattress base or the headboard and the IV pole. The hand or arm may get caught and get injured.
- Each hook's load capacity is 1 kg. Do not hang an article exceeding the load capacity because it may damage the hook, resulting in an injury.
- Length adjustment of the sliding pipe should be kept within 70cm. If the sliding pipe is pulled out too much, it may come off, resulting in an injury or damage.

■ The IV pole is used for hanging intravenous drip bags and similar items.

- ① Insert the IV pole into one of the option attachment holes.
- ② Loosen the knob bolt on the IV pole, and then move the sliding pipe up and down to adjust the length. When the pipe has been adjusted to the desired length, tighten the knob bolt to fasten the pipe.
- ③ Hang the intravenous bags or similar items on the IV pole.

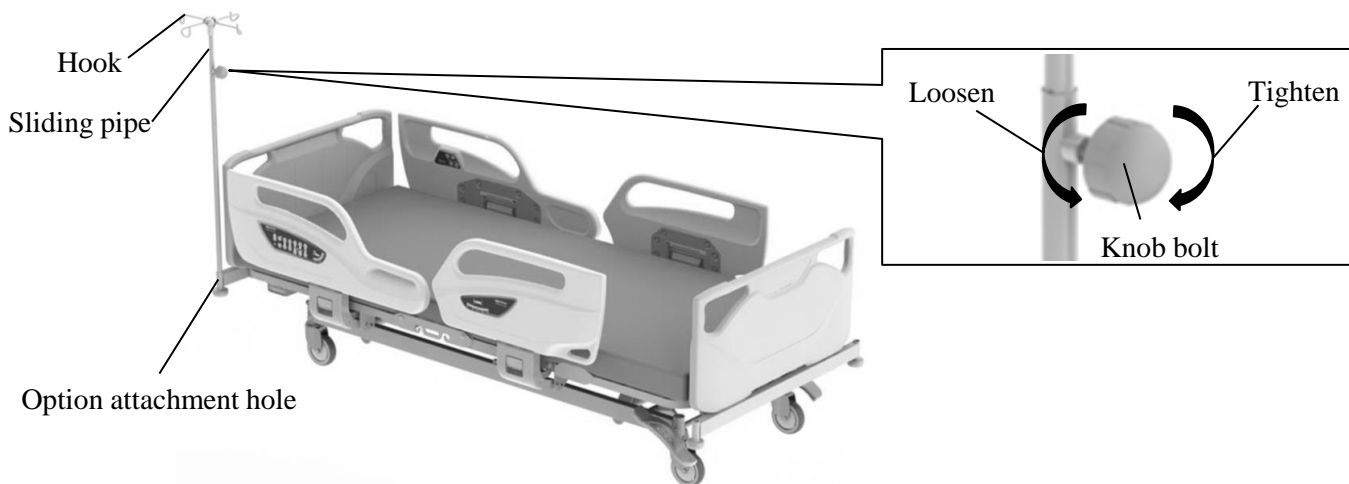

- For any queries, please feel free to contact Paramount Bed or your distributor.

8 ACCESSORIES

3. Oxygen cylinder holder (φ155mm)

WARNING

- Make sure that the knob bolt is firmly tighten. There is a risk of insufficient oxygen supply.
- When using the oxygen cylinder, take care to prevent it from coming into contact with any objects in the vicinity of the bed. There is a risk of an injury by damage of a flow meter or an oxygen cylinder if the cylinder comes into contact with another object.
- Load capacity is 15kg. Do not insert the oxygen cylinder exceeding the load capacity because it may damage the oxygen cylinder holder, resulting in injury.

■ The oxygen cylinder holder can be used by hanged on the headboard.

- ① Hang the oxygen cylinder holder on the headboard.
- ② Loosen the knob bolt on the oxygen cylinder holder, and then slowly insert the oxygen cylinder into the holder from the top.
- ③ Firmly tighten the knob bolt to fasten the oxygen cylinder.

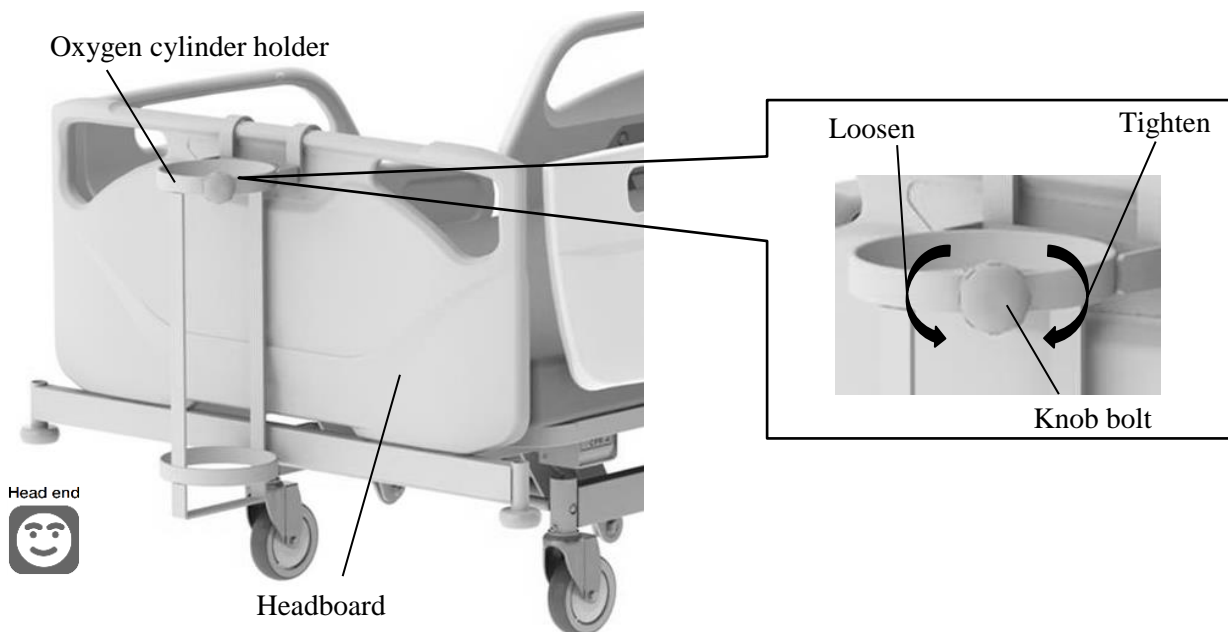

- For any queries, please feel free to contact Paramount Bed or your distributor.

8 ACCESSORIES

4. Oxygen cylinder holder ($\phi 115\text{mm}$)

WARNING

- Make sure that the knob bolt is firmly tighten. There is a risk of insufficient oxygen supply.
- When using the oxygen cylinder, take care to prevent it from coming into contact with any objects in the vicinity of the bed. There is a risk of an injury by damage of a flow meter or an oxygen cylinder if the cylinder comes into contact with another object.
- Load capacity is 15kg. Do not insert the oxygen cylinder exceeding the load capacity because it may damage the oxygen cylinder holder, resulting in injury.

■ The oxygen cylinder holder can be used by inserted into one of the option attachment holes.

- ① Insert the oxygen cylinder holder into one of the option attachment holes.
- ② The oxygen cylinder holder can be set in two positions as shown in figure. After setting, make sure that the oxygen cylinder holder does not rotate.
- ③ Loosen the knob bolt on the oxygen cylinder holder, and then slowly insert the oxygen cylinder into the holder from the top.
- ④ Firmly tighten the knob bolt to fasten the oxygen cylinder.

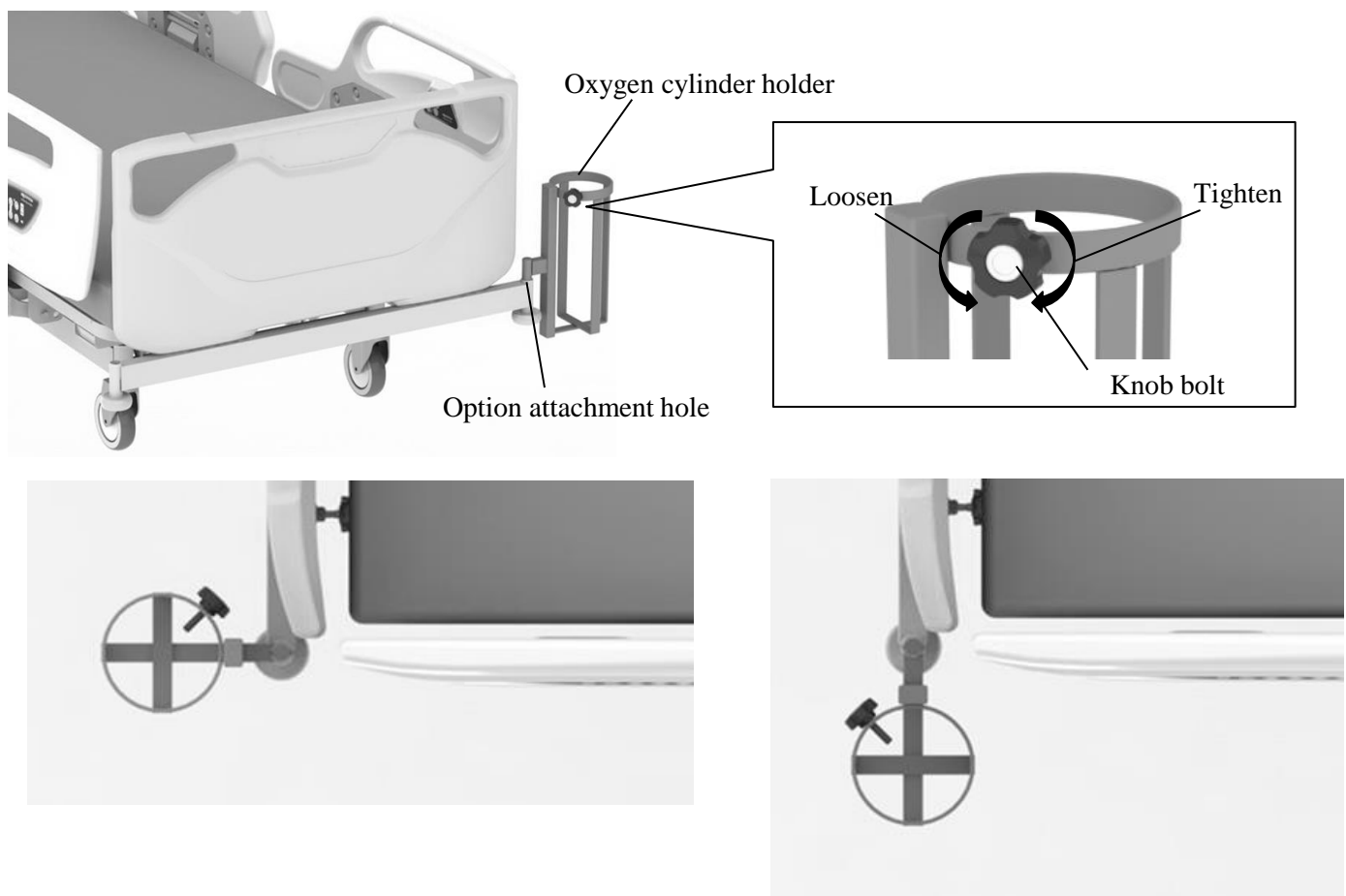

● For any queries, please feel free to contact Paramount Bed or your distributor.

8 ACCESSORIES

5. Lifting pole

WARNING

- Load capacity is 76kg. Do not hang an article exceeding the load capacity because it may damage the lifting pole, resulting in injury.
- During transportation, do not hang on to the lifting pole. It may tip over the bed, the patient on the bed may fall off the bed, resulting in injury.
- Do not detach the headboard when lifting pole is attached, or the head or neck enters the gap between the side-rail and the lifting pole, and there is a risk of injury.

■ The lifting pole can be used for support to raise the body from the bed by attaching to the bed. It can be used for training too.

- ① Attach the parts of the lifting pole to the bed as shown in figure. The parts can be attached on both the right side and the left side of the bed.
- ② Inset the arm into the outer pipe and attach the grip to the arm.
- ③ Tighten the knob bolt to fasten the arm. The arm can be set in three positions as shown in figure by changing the knob bolt positions.
- ④ Pull down the grip to make sure that the lifting pole is attached firmly.

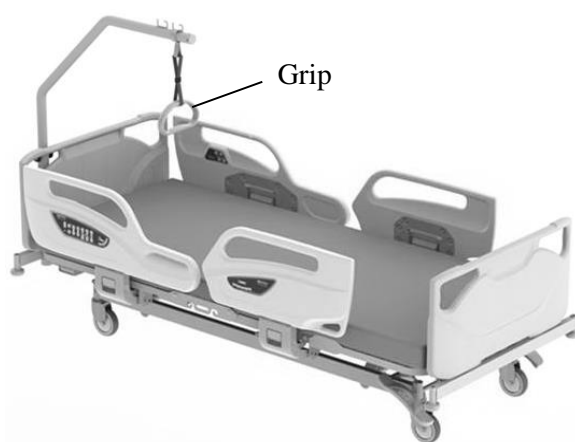
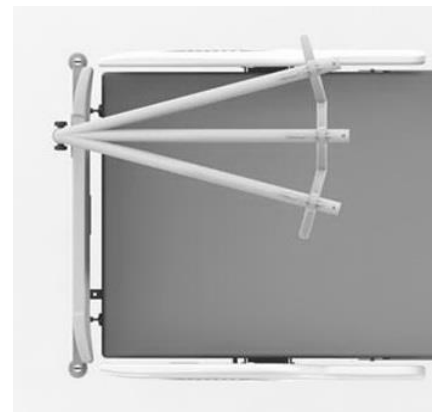
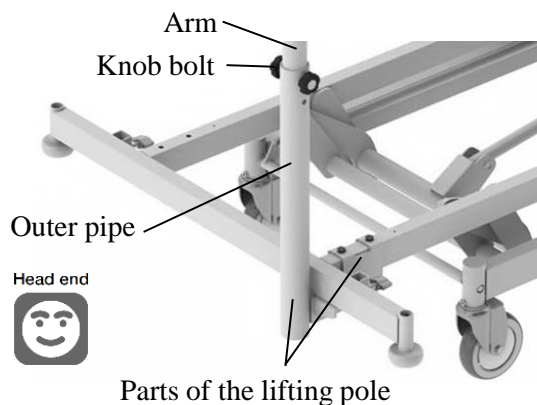

- For any queries, please feel free to contact Paramount Bed or your distributor.

8 ACCESSORIES

6. Foot spacer

WARNING

- Do not use the foot spacer as a hand rail and do not lean against it. The foot spacer may move or be deformed and there is a risk of injury caused by the patient falling off the bed or falling down.
- Be careful not to allow any part of the body (especially the head or neck) to enter a gap between the foot spacer and the side-rail or the footboard.

- The foot spacer can be used for filling in the gap between the footboard and the side-rail. Insert the foot spacer into the option attachment hole.



- When using the extension frame function, the foot spacer cannot be used.
- For any queries, please feel free to contact Paramount Bed or your distributor.

7. Foot spacer storage

- The foot spacer storage can be used for storing the foot spacers.

- ① Hang the foot spacer storage on the footboard outwardly.
- ② Insert the foot spacer insertion part into the hole of the foot spacer storage, and set the foot spacer on the planar section of the foot spacer storage.

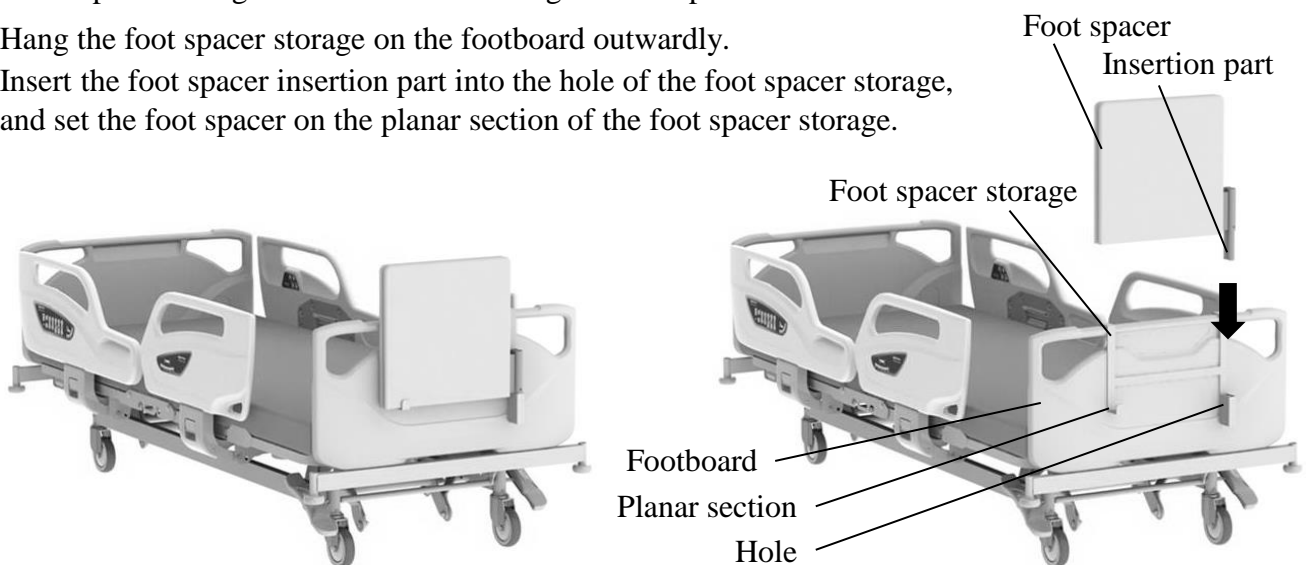

- When using the foot spacer storage, the bed linen rack cannot be used.
- For any queries, please feel free to contact Paramount Bed or your distributor.

8 ACCESSORIES

8. Orthopedic frame attachment

■ The orthopedic frame attachment can be used for attaching the orthopedic frame (KA-86).

- ① Insert the orthopedic frame attachment into the option attachment hole on the foot side of the bed.
- ② Insert a screwdriver into the orthopedic frame and tighten the screw.
- ③ Lightly pull up the orthopedic frame and check that it is attached firmly.

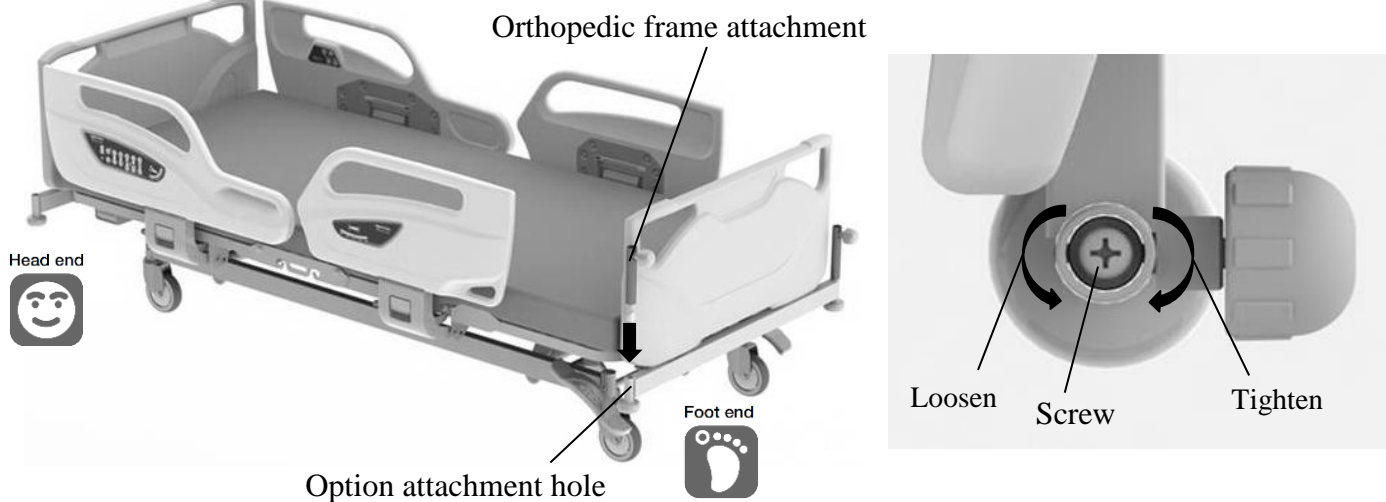

● For any queries, please feel free to contact Paramount Bed or your distributor.

9. Foot light

■ The foot light can be used for illuminating periphery of the feet in the dark.

- ① Fix the footlights on both sides of the main frame of the bed with screws.
- ② Connect the footlights and bed with the attached cables.
- ③ The footlights turn on automatically when the power cable is plugged into the power outlet.

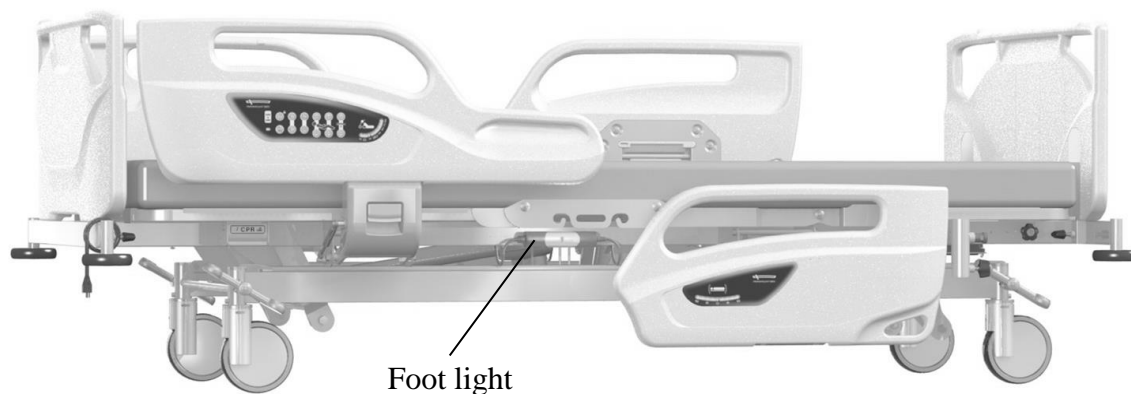

● Some models cannot add-on this option.

● For any queries, please feel free to contact Paramount Bed or your distributor.

10. Monitor table

CAUTION

- When moving the bed, remove any object on the monitor table to prevent the object from falling off.
- Firmly tighten the clamping screws, or the monitor table may accidentally be detached, resulting in injury.
- The maximum load capacity of the monitor table is 20kg. Overloading may damage or deform the monitor table.
- Do not place objects that are hotter than 80°C on the monitor table. This may cause damage or discoloration.
- Do not leave any water or chemicals spills on the monitor table. This may result in damage to the monitor table.
- When lowering the table, take care to prevent the fingers from becoming caught in the gap between the table and the frame.

■ The monitor table can be used for setting a monitor or writing on the table.

- ① Insert the table insertion part into the option attachment holes on foot end of the bed.
- ② Insert a screwdriver into the IV pole attachment hole and tighten the screw.
- ③ Lightly pull up the monitor table and check that it is attached firmly.
- ④ When using the monitor table, rotate the table upward to the horizontal position.
- ⑤ When storing the monitor table, rotate the table downward to the vertical position.

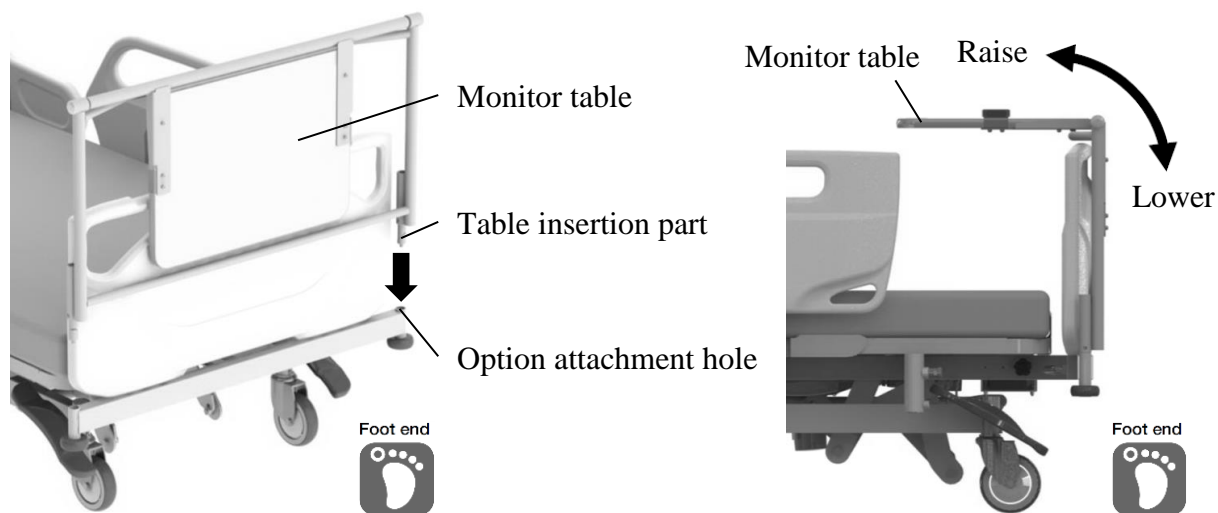

- For any queries, please feel free to contact Paramount Bed or your distributor.

11. Assist bar

WARNING

● Do not attach the assist bar when using the extension frame. A body part may get caught, resulting in injury.

■ The assist bar can be used for supporting to stand from the bed.

[Attaching the assist bar]

* The following figures show the installation on the right side.

- ① Attach the holder to the main frame under the leg section base with the bolts and nuts.
- ② Attach the plunger to the nut for plunger.
- ③ Insert the assist bar insertion part into the holder attachment hole.
- ④ Check that the plunger is correctly inserted into the hole of the assist bar.
- ⑤ Attach the knob bolt to the nut for knob bolt, and tighten it firmly.
- ⑥ Lightly pull the assist bar to make sure that it is attached firmly.

* Must be attached the plunger and knob bolt to the foot end side.

If they are installed on the head end side, they will interfere with the side-rail.

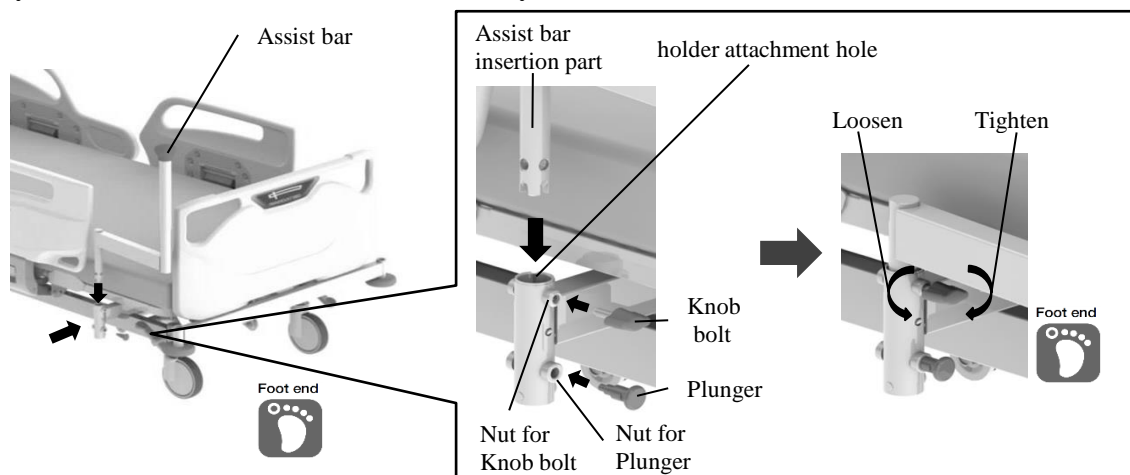

[Using the assist bar]

- ① Loosen the knob bolt.
- ② Pull the plunger and pull the assist bar outward a little.
- ③ Release a hand from the plunger, and pull the assist bar outward until it clicks into place.
- ④ Tighten the knob bolt firmly.
- ⑤ Lightly pull the assist bar to make sure that it is attached firmly.



● Some models cannot add-on this option.

● For any queries, please feel free to contact Paramount Bed or your distributor.

9 PERIPHERAL EQUIPMENTS

Overbed table

WARNING

● Remove the table from bed when performing positioning operations of the bed. Otherwise, the patient may get caught between the table and bed, and may get injured.

■ The overbed table is designed as a table that can support patient to have a meal and work on light duty on the bed.



CAUTION

● The overbed table can be used in the area as shown in figure. When setting the overbed table, pay attention not to hit the caster of the bed because it may damage or deform.

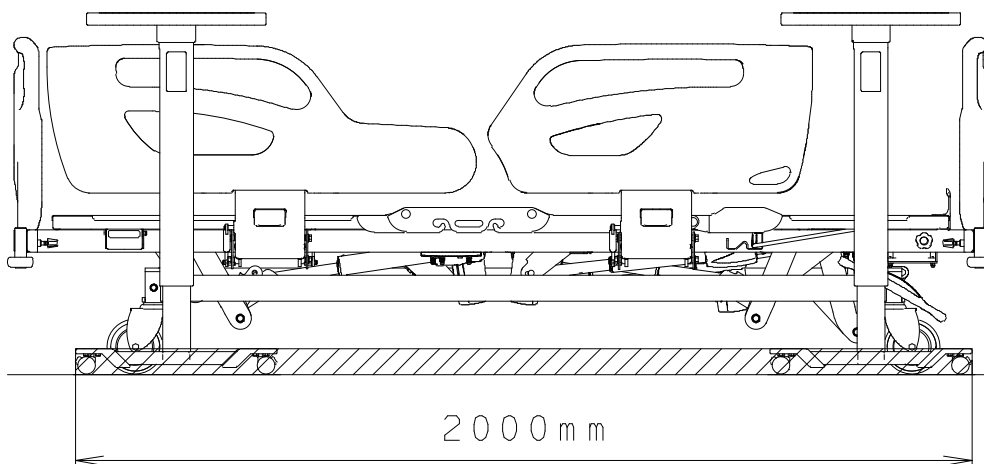













Note: The overbed table can be used within this range.















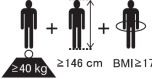

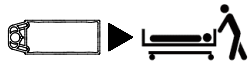
● For any queries, please feel free to contact Paramount Bed or your distributor.

10 PRODUCT SYMBOL DEFINITIONS

■ The symbols below are used for the product.

Symbol	Description
	● CE mark
	● Indoor use symbol
	● Electrical waste
	● Refer to the instruction manual
	● See the instruction manual
	● Type B applied part ● Applied parts are considered to be: Upper frame section, Controllers, Side-rails, Headboard and Footboard.
	● AC input
IPX4	● Protection code
	● Protective ground mark
	● Manufacturer for CE mark
	● Date of manufacture
	● Country of manufacture (Made in China)
	● Country of manufacture (Made in India)
	● Country of manufacture (Made in Vietnam)
SN	● Serial number
#	● Model number
MD	● Medical device (This product is a medical device in Europe, and may be a medical device in some countries and regions depending on their regulations.)

Symbol	Description
	● Authorised representative in the european community
	● Safe working load
	● Maximum user weight
	● Maximum weight (Product weight + Safe working load)
	● The medical bed for adults <small>≥40 kg ≥146 cm BMI≥17</small>
	● 4 casters in locked status (Lock position)
	● 4 casters in unlocked status (Free position)
	● Bed transportation status (steering position)
	● Pull the emergency CPR lever.
	● Do not operate the bed while the patient's body is sticking out of the gap.
	● Do not stand on the side-rail.
	● Take care to prevent the patient's head from getting caught in the gap between the side-rails and the bed.
	● Take care to prevent body part from getting caught in the moving part on the bed.
	● Do not attach the board in the wrong way.
	● Use the suitable mattress described in the instruction manual.

11 REGULAR INSPECTION AND DAILY MAINTENANCE

■ For safety in use, inspect the product regularly, at least once a year. The product exhibits wear and deterioration according to the frequency and conditions of use. Inspect for loose parts, the operation of moving parts on the bed, and the presence of damage regularly. When an irregularity has been noticed or when a detailed inspection is desired, contact Paramount Bed or your distributor.

	Operation details	Inspection items
Bed Unit	Back raise operation (p.17 to p.23)	Proper operation can be achieved.
		There must not be any strange noises.
	Knee raise operation (p.17 to p.23)	Proper operation can be achieved.
		There must not be any strange noises.
	Hi-lo and TR/RTR operations (p.17 to p.22)	Proper operation can be achieved.
		There must not be any strange noises.
Miscellaneous		There must not be any scratches and deformation at the mattress base, frame, or any other parts.
		There must not be any deformation, damage, or detachment of bumpers, resin parts or elastic parts.
		There must not be any peeling of labels, and the text must be legible.
Board	Board mounting condition (p.14)	The board stopper must be locked properly.
		There must not be any remarkable rattling.
Casters	Traveling	There must not be any strange noises when the bed is traveling.
		There must not be any strange vibrations when the bed is traveling.
	Caster locking operation (p.26 to p.27)	Proper operation can be achieved.
		The operation must not be unusually difficult.
		The bed must not move when the casters are locked.
		The bed must move smoothly when the lock is released.
Bed side-rail	Bed side-rail operation (p.28 to p.29)	When in steering position, swiveling of the steering caster must be locked.
		Proper operation can be achieved.
		There must not be any strange noises or remarkable rattling.
Electrical part	Visual check of electrical parts	The operation must not be unusually difficult.
		Cable must not get tangled in the bed.
		Plugs and cables must have no scratches or damage.
		There must not be any scratches and damage on the handheld controller.

11 REGULAR INSPECTION AND DAILY MAINTENANCE

■ Lubrication (if there is abnormal noise)

- Lubrication is needed if there is abnormal noise. Please feel free to contact Paramount Bed or your distributor to be lubricated.



- The water adhesion to the bed or the mattress, or moisture may cause corrosion, abnormal noise or contamination. If water adhere to the bed or the mattress, wipe off immediately.

■ Bed unit

- To clean the bed, use a cloth that has been soaked in diluted detergent and wrung out well, then wipe off any residual detergent with a cloth soaked in water and wrung out well. Finally, use a dry cloth to wipe the bed to ensure it is dry.

WARNING

- To prevent accidents caused by incorrect operation, always unplug the power plug from the outlet before cleaning.
- Do not splash water to clean the bed. there is a risk of electric shock due to a short circuit.

- Always dilute any detergents used as specified below.

76.9% - 81.4% ethanol for disinfection

0.05% - 0.2% benzalkonium chloride (e.g. Osvan)

0.05% - 0.2% benzethonium chloride (e.g. Hiamine)

0.05% chlorhexidine gluconate (e.g. Hibitane)

0.02% - 0.05% sodium hypochlorite (e.g. Milton)

CAUTION

- Do not use volatile cleaning fluids (such as paint thinner, benzene or gasoline) and cresol. Discoloration or deterioration could result.

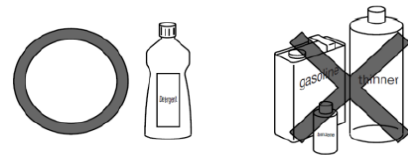

- The product cannot be used with an ozone sterilizer or an autoclave sterilizer, etc.

■ Accessories

- Follow the instructions described in the instruction manual for the respective accessory.

12 TROUBLESHOOTING

- Problems may not always indicate faults. Check the following once again before requesting repair.
- If the problem persists after taking corrective actions, stop using the bed immediately, disconnect the power plug from the outlet, and contact Paramount Bed or your distributor for repair.
- Bed damaged in earthquakes, fires, floods or other incidents must be inspected and repaired by Paramount Bed or your distributor. Otherwise, there is a risk of electric shock or fire due to short circuit or current leakage from electrical parts, of injury due to malfunctioning caused by deformation of the bed.

Problem	Check	Corrective action	Reference page
● The bed does not move even when the handheld controller, the side-rail integrated panel or the patient control panel buttons are pressed.	● Check if the power plug is plugged into the outlet.	● Plug the power plug into the outlet.	16
	● The power plug is plugged into the outlet but the bed still does not move.	● Unplug the power plug from the outlet and plug it in again. ● Plug another electrical device into the outlet to check that power is available.	16
● The bed does not move even when the handheld controller buttons are pressed.	● Check if the Lock-out switch is in the lock position.	● Rotate the switch to the unlock position.	20
	● Check if the bed was operated continuously.	● Reset the protect condition.	19
● The bed does not move even when the side-rail integrated panel and the patient control panel buttons are pressed.	● Check if the side-rail integrated panel and the patient control panel lock function is OFF.	● Press the lock button to switch the side-rail integrated panel and the patient control panel lock function OFF.	22
	● Check if the bed was operated continuously.	● Reset the protect condition.	22
● Beeping alert sound occurred when the handheld controller, the side-rail integrated panel or the patient control panel buttons are pressed.	● Check if the battery is charged.	● Plug the power plug into the outlet.	34
● The bed cannot be positioned correctly.	● Check if there is nothing in the moving parts on the bed.	● Remove any obstacles.	-
● The bed cannot be moved.	● Check if the casters are locked.	● Unlock the caster.	26-27
● The bed does not move in the intended direction when the patient is being transported.	● Check if the caster is in the steering position.	● Unlock the caster in the steering position.	26
● The board will not come off.	● Check if the board is locked.	● Unlock the board stoppers.	14
● Abnormal ticking sound occurred during back raise operation.	● Check if emergency CPR function is operated previously.	● Press the [↓] button of the back raise adjustment buttons on the handheld controller or the side-rail integrated panel for more than 5 seconds in power on status.	19, 21, 24

12 TROUBLESHOOTING

Problem	Check	Corrective action	Reference page
●Noises when emergency CPR function is operated.	●Check if the CPR lever fully pull/grip when in use.	●Pull/Grip fully to the CPR lever when in use.	24
●Back raise cannot move in up direction even when the handheld controller, the side-rail integrated panel or the patient control panel buttons are pressed.	●Check if emergency CPR function is operated previously.	●Press the [↓] button of the back raise adjustment buttons on the handheld controller or the side-rail integrated panel for more than 5 seconds in power on status.	19, 21, 24

●When requesting repairs or contacting Paramount Bed or your distributor, please provide the number on the product ID label.

Product ID label locations

Product ID labels are affixed to the foot end of the main frame and on the inside of the footboard.

<Main frame>

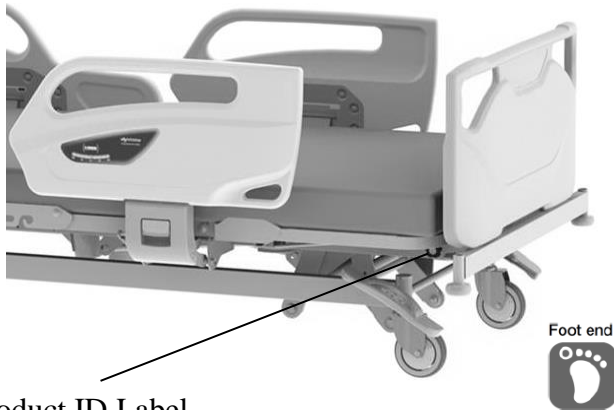

<Footboard>



Product ID Label <CA-5**** Series>

PARAMOUNT BED
NAME Electrical Hospital Bed
CA-54380
CA543801415A0020A
SN 9001007 00001
INPUT: 100-240V ~ 50/60Hz 500VA
DUTY: 2min ON/18min OFF

PARAMOUNT BED CO., LTD. EMERGO EUROPE
14-5-2-chome, Higashisuna Prinsessegracht 20,2514 AP
Koto-ku, Tokyo, 136-8670, Japan The Hague, The Netherlands

Product ID Label

PARAMOUNT BED 2020-01
CAB33CAE-0020A
SN 9001007 00003

<MA-5****V Series>

PARAMOUNT BED
NAME Electrical Hospital Bed
MA-54380V
MA54380V8411A0020A
SN 9001007 00001
INPUT: 100-240V ~ 50/60Hz 500VA
DUTY: 2min ON/18min OFF

PARAMOUNT BED CO., LTD. EMERGO EUROPE
14-5-2-chome, Higashisuna Prinsessegracht 20,2514 AP
Koto-ku, Tokyo, 136-8670, Japan The Hague, The Netherlands

<IA-5**** Series>

PARAMOUNT BED
NAME Electrical Hospital Bed
IA-54380
IA543801422A0020A
SN W000283 00001
INPUT: 100-240V ~ 50/60Hz 500VA
DUTY: 2min ON/18min OFF

PARAMOUNT BED INDIA PVT. LTD.
Plot Number 430, Sector 8, IMT Manesar, 122050 Gurugram,
Haryana, INDIA

PARAMOUNT BED CO., LTD.
14-5-2-chome, Higashisuna,
Koto-ku, Tokyo, 136-8670, Japan
EMERGO EUROPE
Prinsessegracht 20,2514 AP
The Hague, The Netherlands

Product lifetime

The lifetime of this equipment is typically eight (8) years. Lifetime is defined as the period during which the product will maintain the specified performance and safety, provided it has been maintained and operated in conditions of normal use in accordance with the requirements in this instruction manual.

13 LONG-TERM STORAGE

■ The following precautions should be noted when the bed is not in use for extended periods of time.

1. Lay the back and knee section bases flat.
2. Lower the bed to the lowest position.
3. Do not place objects other than mattress on the bed.
4. Do not place any objects on the mattress.
5. Do not place location that tend to be exposed to high temperatures, high humidity, low temperatures, dry or dusty conditions.
Store at a temperature between -10°C and 50°C , humidity between 20%RH and 90%RH at 30°C , and atmospheric pressure between 700hPa and 1060hPa.
6. Store the bed horizontally; do not stand it upright against wall.
7. For electrically-operated beds, be sure to disconnect the power plug from the power outlet and the plug of battery from the control box, and wind the power cable onto the main frame.
(See p.16)



- Inspect the product regularly at least once a year, even if it is during storage.

Bed disposal

When the A5 series bed has reached the end of its usable life, discard it according to local standards.

14 SPECIFICATIONS

*Subject to normal manufacturing tolerances

Family Name		A5 Series	
Product Name		Electrical Hospital Bed	
Model No. (*1)		CA-53380 / IA-53380	CA-54380 / IA-54380 / MA-54380V
Quantity of motors		3 Motors	4 Motors
Operation Procedure	Auto contour	Motorized	
	Back raise	Motorized	
	Knee raise	Motorized	
	Hi-lo adjustment	Motorized	
Power supply voltage / frequency		100-240VAC / 50 / 60Hz	
Dimensions	Total length	2,200mm (When the extension frame is retracted) 2,300mm (When the extension frame is used)	
	Total width	990mm	
	Total height	755[+20, -10] to 1,105[+20, -10]mm (125mm dia. Casters) 775[+20, -10] to 1,125[+20, -10]mm (150mm dia. Casters)	
	Mattress base length	2,000mm	
	Mattress base width	860mm	
	Mattress base height	350[+20, -10] to 700[+20, -10]mm (125mm dia. Casters) 370[+20, -10] to 720[+20, -10]mm (150mm dia. Casters)	
	Power cable length	Effective length: 2,500mm	
Product weight		115kg	
Material	Mattress base	Made of steel, powder coating (part is resin mold item)	
	Main frame	Made of steel, powder coating (part is resin mold item)	
	Side rail	PE resin mold items	
	Headboard / Footboard	PE resin mold items	
Safe working load (*2)		230kgf (2,250N)	
Back raise	Inclination angle	0° to 70° [+3, -7]°	
	Time required	23sec. (*3)	
Knee raise	Inclination angle	0° to 25° [±4]°	
	Time required	7sec. (*3)	
Hi-lo adjustment	Height range	350mm	
	Time required	31sec. (*3)	22sec. (*3)
TR inclination	Inclination angle	-	0° to 12° [+3, -0]°
	Time required	-	22sec. (*3)
Actuator Type		Linear actuator (DC motor)	
Power consumption		500VA or less	
Maximum continuous operation time		2 min. (stop time: 18min. (*4))	
Battery rated capacity		1.3 Ah 24V	
Patient target group	User weight (min. - max.)	40 to 195 kg	
	Minimum user height	146 cm	
	Minimum user body mass index (BMI)	17	
	Supported age range	13 years and older	
Intended users		Medical professionals (Doctors, nurses, etc.), patients, close relatives of patients, and maintenance staff	

*1) CA model, IA model and MA model differ in label description, etc. For more information about specification, please feel free to contact Paramount Bed or your distributor.

*2) Safe working load: Maximum load with which the bed can be operated. (The total load of user's weight and incidental items including accessories.)

*3) With no loads.

*4) Time to protect electrical parts from overheating when the bed is used continuously for maximum continuous operation time (2min).

14 SPECIFICATIONS

Environmental conditions	Range	
	When transported or stored	When in use
Temperature	-10 to 50°C	5 to 40°C
Humidity	20 to 90%RH at 30°C	20 to 90%RH at 30°C
Air pressure	700 to 1,060hPa	700 to 1,060hPa

● Essential performance

Function to support the body of patient, Emergency CPR (back lower) function.

● Frequently used functions

Back-raising, Knee-raising, Height adjustment and Side-rail raising and lowering operation.

● Clinical benefits

- Patient comfort
- Quality Patient Care and efficient care provision

● Classification and Standards

The electric hospital bed is designed and manufactured according to the following equipment classification and standards.

- Classification as medical device in Europe : Class 1
- Safety standards applied : IEC 60601-1:2005 + CORR. 1:2006 + CORR. 2:2007 + AM1:2012
: IEC60601-1-2: 2014
: IEC60601-2-52: 2009 (First Edition) for use with IEC 60601-1:2005 (Third Edition)
: EN 60601-1:2006 +A12:2014
: EN 60601-1-2:2015
: EN60601-2-52:2010
- Electric shock protection : Class 1 , Type B
- Application environment (in IEC60601-2-52:2009) : 1 and 2

※ Equipment not suitable for use in the presence of a flammable anaesthetic mixture.

14 SPECIFICATIONS

The A5 series requires special safety precautions regarding EMC to be observed. Install, operate, and use the A5 series according to the information provided below.

The A5 series is intended for use in an electromagnetic environment specified according to “Electromagnetic interference”. Using the A5 series in an unintended environment may result in the occurrence of the following problems.

- The function for supporting the patient’s body weight may not be maintained.
- The emergency back-lowering function may not be maintained.

No.	Cable	Maximum length [m]	Remarks
1	AC power cable	4.6	Without shield
2	Handheld controller cable	1.5	Without shield

The A5 series is intended for use in doctor’s offices, clinics, exclusive medical facilities, independent surgery centers, multiple treatment facilities, hospitals (except near high-frequency surgical equipment, and outside RF shielded rooms for magnetic resonance images). The customers or users of the A5 series must ensure that the A5 series is always used in this environment.

Due to its emission characteristics, the A5 series is suitable for use in hospitals. If used in a home environment, this device may not offer sufficient protection against radio frequency communication services. It may be necessary for the user to take relaxation measures such as re-arranging or changing the direction of the device.

WARNING

- If accessories, transducers, or cables other than those specified and sold by the manufacturers of the A5 series are used as replacement parts for internal components, it may result in an increase in emission or a decline in immunity of the A5 series.
- Use portable RF communication devices (including antenna cables and peripheral devices such as external antennas) at a distance of at least 30 cm from all parts of the A5 series. Using the RF communication devices within a distance of 30 cm may cause a decline in the performance of the A5 series.
- The A5 series cannot be used adjacent to another device or in a stacked state. If the A5 series must be used adjacent to another device or in a stacked state, make sure the A5 series operates appropriately at the location of use.

Guidance and Manufacturer's Declaration - Electromagnetic Emissions

The A5 series is intended for use in the electromagnetic environments specified below.
The customer or the user of the A5 series must use it in an environment specified here.

Emission test	Compliance	Electromagnetic Environment - Guidance
RF emissions CISPR 11	Group 1	The A5 Series is suitable for use in all establishments other than domestic and those directly connected to the public low-voltage power supply network that supplies buildings used for domestic purposes.
RF emissions CISPR 11	Class A	
Harmonic emissions IEC 61000-3-2	Class A	
Voltage fluctuations / Flicker emissions IEC 61000-3-3	Complies	

14 SPECIFICATIONS

Guidance and Manufacturer's Declaration — Electromagnetic Immunity

The A5 Series is intended for use in the following electromagnetic environment. The customer or user of the A5 Series must use it in an environment specified here.

Immunity test	IEC 60601-1-2 Test level	Compliance level
Electrostatic discharge (ESD) IEC 61000-4-2	Contact discharge: $\pm 8\text{kV}$ Air discharge: $\pm 2\text{kV}, \pm 4\text{kV},$ $\pm 8\text{kV}, \pm 15\text{kV}$	Contact discharge: $\pm 8\text{kV}$ Air discharge: $\pm 2\text{kV}, \pm 4\text{kV},$ $\pm 8\text{kV}, \pm 15\text{kV}$
Electrical fast transient/ burst IEC 61000-4-4	Power supply line: $\pm 2\text{kV}$ Input/output Lines: $\pm 1\text{kV}$	Power supply line: $\pm 2\text{kV}$ Input/output Lines: $\pm 1\text{kV}$
Surge IEC 61000-4-5	Line to line: $\pm 0.5\text{kV}, \pm 1.0\text{kV}$ Line to earth: $\pm 0.5\text{kV}, \pm 1.0\text{kV}, \pm$ 2.0kV	Line to line: $\pm 0.5\text{kV}, \pm 1.0\text{kV}$ Line to earth: $\pm 0.5\text{kV}, \pm 1.0\text{kV}, \pm$ 2.0kV
Voltage dips, instantaneous power failure, and voltage fluctuation in power supply cable IEC 61000-4-11	0.5 cycle for test level 0% UT (Phase: at $0^\circ, 45^\circ, 90^\circ, 135^\circ, 180^\circ,$ $225^\circ, 270^\circ$ and 315°)	0.5 cycle for test level 0% UT (Phase: at $0^\circ, 45^\circ, 90^\circ, 135^\circ, 180^\circ,$ $225^\circ, 270^\circ$ and 315°)
	1 cycle for test level 0% UT and 25/30 cycles for test level 70% UT (Single phase: at 0°)	1 cycle for test level 0% UT and 25/30 cycles for test level 70% UT (Single phase: at 0°)
Short-term power failure IEC 61000-4-11	250/300 cycles for test level 0% UT	250/300 cycles for test level 0% UT
Power frequency (50/60Hz) magnetic field IEC 61000-4-8	30 A/m	30 A/m

Note: UT is the AC power voltage before applying the test level.

14 SPECIFICATIONS

Guidance and Manufacturer's Declaration - Electromagnetic Immunity

The A5 Series is intended for use in the following electromagnetic environment. The customer or user of the A5 Series must use it in an environment specified here.

Immunity test	IEC 60601 Test level	Compliance level	Electromagnetic Environment - Guidance
RF Conductivity IEC 61000-4-6	3 V 0.15 MHz to 80 MHz 6 V ISM bandwidth between 0.15 MHz and 80 MHz 80% amplitude modulation (1 kHz)	3 V 0.15 MHz to 80 MHz 6 V ISM bandwidth between 0.15 MHz and 80 MHz 80% amplitude modulation (1 kHz)	Field strengths from fixed RF transmitters, as determined by an electromagnetic site survey, must be less than the compliance level in each frequency range. Interference may occur in the vicinity of equipment marked with the following symbol:
Radioactive RF electromagnetic field IEC 61000-4-3	3 V/m 80 MHz to 2.7 GHz 80% amplitude modulation (1 kHz)	3 V/m 80 MHz to 2.7 GHz 80% amplitude modulation (1 kHz)	

- a. Field strengths from fixed transmitters, such as those of base stations for radio (cellular/cordless) telephones, land mobile radios, amateur radios, AM and FM radio broadcasts, and TV broadcasts cannot be predicted theoretically with accuracy. To determine the electromagnetic environment due to fixed RF transmitters, an electromagnetic survey of the site should be considered. If the measured field strength in the location in which A5 series is used exceeds the applicable RF compliance level above, A5 series should be observed to verify whether or not it is operating appropriately. If an abnormal operation is seen, take additional measures as needed, such as changing the location of use of the A5 series.
- b. These guidelines may not apply in all situations. Electromagnetic propagation is affected by absorption and reflection from structures, objects, and people.

14 SPECIFICATIONS

Guidance and Manufacturer's Declaration - Electromagnetic Immunity

The A5 series is intended to be used in an electromagnetic environment where RF radio communication devices are used. The electromagnetic interference between the RF communication device and the A5 series can be prevented by maintaining the minimum distance between the two as recommended below in accordance with the maximum output and frequency of the communication device.

Immunity test	IEC 60601-1-2 Test level	Compliance level	Bandwidth (MHz)	Service	Modulation	Maximum output (W)	Distance (m)
Proximate electromagnetic field IEC 61000-4-3	27V/m 385MHz	27V/m	380 to 390	TETRA 400	Pulse modulation 18Hz	1.8	0.3
	28V/m 450MHz	28V/m	430 to 470	GMRS 460, FRS460	Pulse modulation 18Hz	2	0.3
	9V/m 710MHz	9V/m	704 to 787	LTE band 13, 17	Pulse modulation 217Hz	0.2	0.3
	9V/m 745MHz						
	9V/m 780MHz						
	28V/m 810MHz	28V/m	800 to 960	GSM 800/900, TETRA 800, iDen 820, CDMA 850, LTE band 5	Pulse modulation 18Hz	2	0.3
	28V/m 870MHz						
	28V/m 930MHz						
	28V/m 1720MHz	28V/m	1700 to 1990	GSM 1800; CDMA 1900; GSM 1900; DECT; LTE band 1, 3, 4, 25; UMTS	Pulse modulation 217Hz	2	0.3
	28V/m 1845MHz						
	28V/m 1970MHz						
	28V/m 2450MHz	28V/m	2400 to 2570	Bluetooth, WLAN, 802.11 b/g/n, RFID 2450, LTE band 7	Pulse modulation 217Hz	2	0.3
	9V/m 5240MHz	9V/m	5100 to 5800	WLAN 802.11 a/n	Pulse modulation 217Hz	0.2	0.3
	9V/m 5500MHz						
9V/m 5785MHz							

15 AFTER-SALES SERVICE

1. When requesting repairs

First check the items described in “12. TROUBLESHOOTING” (p. 51, 52) in this instruction manual. If the problem persists, disconnect the bed's power plug from the power outlet and contact Paramount Bed or your distributor.

■ Details necessary when requesting repair

- Product name, model number
- Product ID label number (see p.52)
- Date of purchase
- Details of fault or problem (please provide as much detail as possible)
- Your name, organization, address, and phone number

■ Consumable parts

Mattress, casters, handheld controller, battery, the rubber parts are consumable parts.

2. Minimum stock availability period

Paramount Bed keeps replacement parts (necessary to maintain bed performance) in stock for at least 8 years after the discontinuation of production.



3. Questions regarding after-sales service

For any queries, please feel free to contact your distributor or to the following address.

Website: <https://www.paramount.co.jp/english/>

[Location in Japan]	[Location in China]
 PARAMOUNT BED CO., LTD. 14-5, 2-chome, Higashisuna, Koto-ku, Tokyo, 136-8670, Japan TEL : +81-(0)3-3648-2961 FAX : +81-(0)3-3648-5781	PARAMOUNT BED (CHINA) CO., LTD. Plot A-105, Wuxi National Hi&New Tech Industrial Development Zone, Wuxi, Jiangsu, 214028, China Tel : +86-510-85323205 FAX : +86-510-8532-3212

[Location in Vietnam]	[Location in India]
PARAMOUNT BED VIETNAM CO., LTD Lot H-1, Long Duc Industrial Park, Long Duc Ward, Long Thanh District, Dong Nai Province, Vietnam Tel: +84-251-368-1181	PARAMOUNT BED INDIA PVT. LTD. Plot Number 430, Sector 8, IMT Manesar, 122050 Gurugram, Haryana, INDIA Tel : +91-124-4205748



EMERGO EUROPE

Prinsessegracht 20
 2514 AP, The Hague
 The Netherlands

NOTES

NOTES

 PARAMOUNT BED